



www.hikvision.com

HIKVISION

2018 Q3 EU CCTV CATALOGUE

Professional series

www.magazijninrichtingshop.nl

HIKVISION UNAUTHORIZED DISTRIBUTORS POLICY

Hikvision Europe sells products only through authorized distributors. We value our industry partners and are proud of the relationships we have developed to help expand the use of our innovative technology products and solutions. These authorized distributors have committed to serve as a link in the Hikvision Europe value chain by providing excellent pre- and post-sale customer service, including full firmware and sales engineering support.

Not every distributor advertising Hikvision products has been authorized by Hikvision Europe to advertise or sell those products. We warn potential customers against purchasing these "gray market" products from unauthorized distributors. Unauthorized distributors may be selling counterfeit, used, or damaged product. Much of the products sold by unauthorized distributors have been altered with modified firmware. Since this means that it is no longer in original factory condition, Hikvision warranty is void, per company policy.

We warn potential customers against purchasing from unauthorized distributors. Purchasing through authorized Hikvision Europe distributors ensures that you receive the benefits of technical support, project registration, dealer loyalty programs and advance replacement of any camera, recorder, monitor, video server, or software, in addition to Hikvision Europe full warranty. Additionally, products purchased through authorized distribution partners have additional features and capabilities that distinguish the Europe offering.

If you have any questions or concerns about the official status of your Hikvision distributor before your purchase, please contact Hikvision Europe Customer Service at support.eu@hikvision.com to confirm their authorized status.

Thank you for your continued support of our industry-leading video surveillance products.

ABOUT HIKVISION

It started with cutting-edge technology: high definition IP cameras, digital video servers, hybrid and standalone DVRs, NVRs, speed domes, encoders and decoders. And momentum continues to develop new technologies for a safer future.

Strengthened by one of the largest R&D teams in the video surveillance industry, the innovation behind these products quickly made Hikvision the #1 CCTV and video surveillance equipment provider in the world (2017 IHS Report). A total solution provider, Hikvision manufactures a full suite of video surveillance products and solutions for a broad range of vertical markets, including retail, education, and many others. Whatever the scope or requirements of the application, Hikvision has a user-friendly, highly scalable product to meet those needs.

www.magazijnrichtingshop.nl - info@magazijnrichtingshop.nl - tel. +31(0)26-3633683



www.magazijninrichtingshop.nl - info@magazijninrichtingshop.nl - tel. +31(0)26-3633683

CONTENTS

01 IP CAMERAS	16 - 31	06 TURBO HD PTZ CAMERAS	63 - 66	11 ENCODERS	85
Economic Series	18 - 24				
Professional Series	25 - 31				
02 IP PTZ CAMERAS	32 - 35	07 DVRS	67 - 74	12 KEYBOARD	86 - 87
Economic Series	33 - 34	Entry-level series	69	Network Keyboard	86
Professional Series	35	Economic series	70 - 71	RS-485 Keyboard	87
		Professional series	72 - 74		
03 PANOVU CAMERAS	36 - 37	08 DISPLAYS	75 - 78	13 ACCESSORIES	88 - 98
		LED Monitor	76 - 77	Transmission accessory	88
04 NETWORK VIDEO RECORDERS	38 - 42	LCD Monitor	78	Network Cable	89
Economic Series	39 - 40			HDD	90
Professional Series	41 - 42	09 SWITCHES	79 - 82	Intelligent Storage	91
		Unmanaged PoE Switch	79 - 80	PoE Video Repeater	92
05 TURBO HD CAMERAS	43 - 62	Web-managed PoE Switch	81	Microphone	93
Economic Series	47 - 52	Unmanaged non-PoE switch	82	Bracket	94 - 98
Professional Series	53 - 62	10 DECODERS	83 - 84		
		6400 series Decoder	83		
		6900 series Decoder	84		

www.magazijninrichtingshop.nl - tel. +31(0)26-3633683

MODEL NAME CODING RULE

Network Camera

DS-2	C	D	4	0	2	4	F	-A
------	---	---	---	---	---	---	---	----

DS-2CD

Hikvision Camera

Product Line

6: 6-Line, Pro camera
4: 4-Line, Smart IPC
2: 2-Line, entry-level camera

Product form factor

Odd number: dome or mini dome form
Even number: box or bullet form

Resolution

12: 1.3 Megapixel
24/25: 2 Megapixel
32/35: 3 Megapixel
52: 5 Megapixel
65: 6 Megapixel

Product information

F: support on-board storage
WD: WDR

Postfix

-I: IR
-Z: Motorized VF lens
-H: built-in heater
-S: Audio/Alarm IO
-A: Auto back focus
-P: P-Iris
-W: Wi-Fi
-V: Outdoor version
-10: Cylindrical sensor unit (only for covert camera)
-20: L-shaped sensor unit (only for covert camera)
-30: Tube sensor unit (only for covert camera)

PTZ Dome Camera

DS-2	D	F	7	2	3	0	(T)	(N)	(I)	-	A(E)	(3)	(L)
------	---	---	---	---	---	---	-----	-----	-----	---	------	-----	-----

DS-2

HIKVISION camera

Product type

D: Network
A: Analog

Size

2: 2"(2.5")
4: 4"
5: 5"
6: 6"
7: 7"(IR)
8: 8"(IR)

Product line

F: High-end
E: Mid/Entry-level

Resolution

0: WD1 or 700TVL
1: 1.3MP or 1MP
2: 2MP
3: 3MP
4: 4MP
5: 5MP
6: 6MP

Optical zoom

03: 3X
10: 10X
12: 12X
20: 20X
23: 23X
30: 30X
37: 37X

Blank: PAL
N: NTSC

Blank: RJ45/BNC interface
T: HDTVI interface
S: SDI interface

Blank: Non-IR PTZ
I: IR PTZ
IS: 500m Laser PTZ

Power

A: 24 VAC
D: 12 VDC
AE: 24VAC&PoE
DE: 12VDC&PoE

Enhanced

Blank: none
L: low-temperature
W: wiper

Blank: outdoor
3: indoor (ceiling/in-ceiling)
4: indoor (others)

www.magazijninrichtingshop.nl - info@magazijninrichtingshop.nl - tel. 31(0)26-3633683

MODEL NAME CODING RULE

Analog Camera

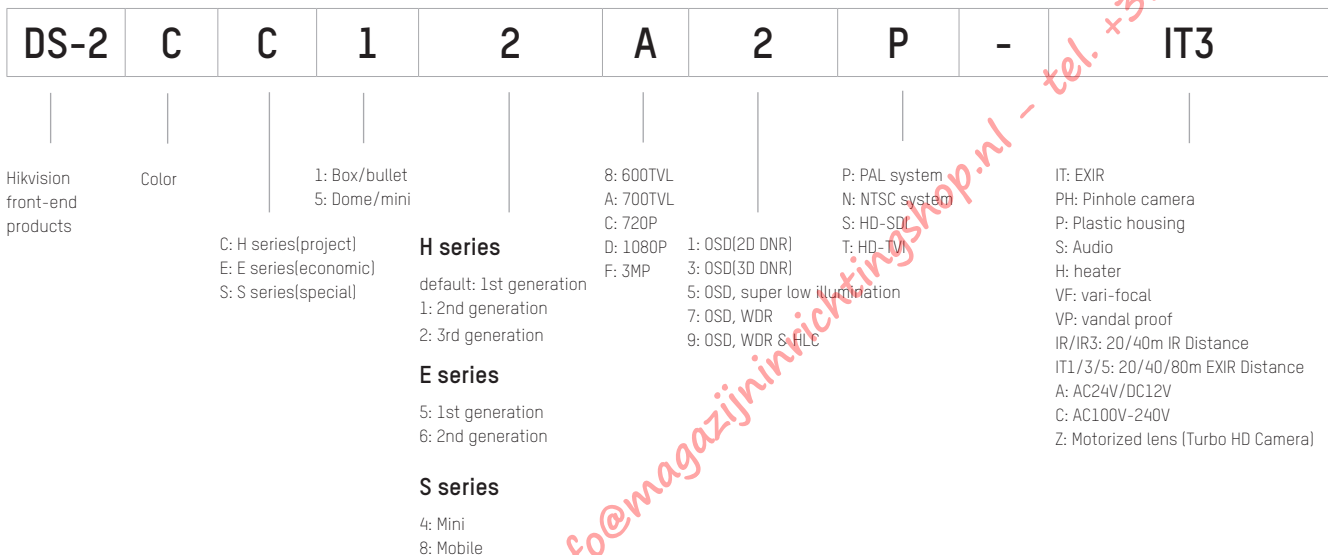

DVR

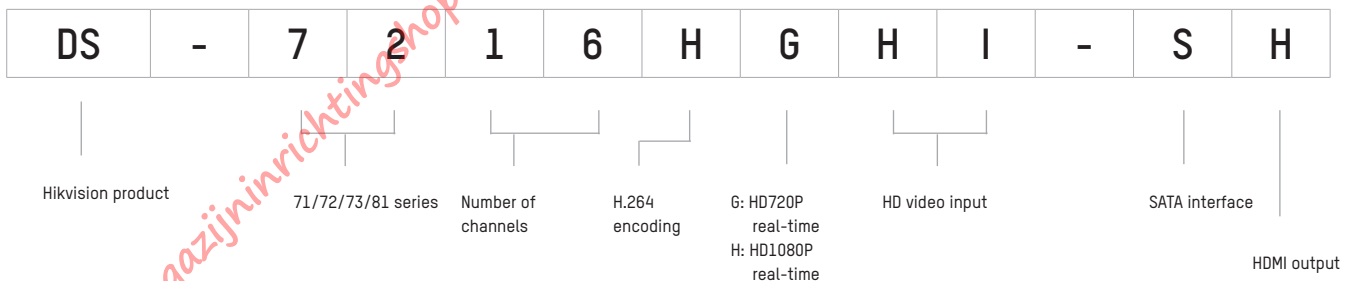

www.magazijnrichtingshop.nl - info@magazijnrichtingshop.nl - tel. +31(0)26-3633683

MODEL NAME CODING RULE

NVR

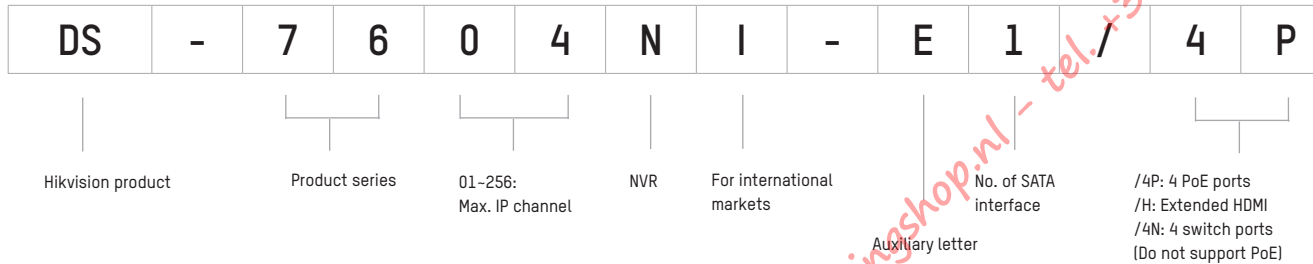

Video Encoder

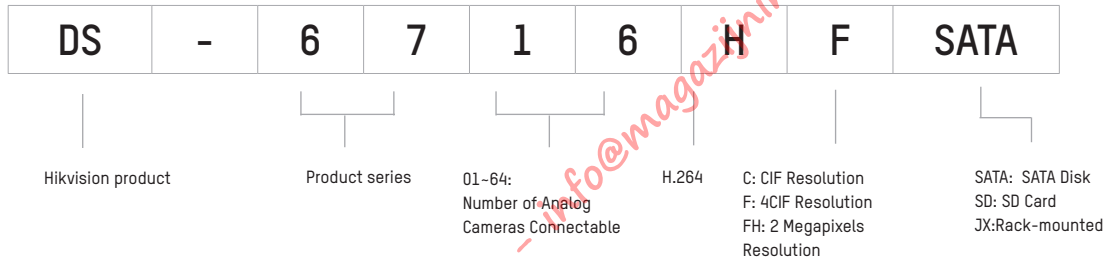

www.magazijninrichtingshop.nl - info@magazijninrichtingshop.nl - tel. +31(0)26-3633683



ECOSYSTEM PARTNERSHIP PROGRAM FOR TECHNOLOGY INTEGRATION PARTNERS- BUILD SMART SOLUTIONS WITH HIKVISION

BUSINESS DEVELOPMENT SUPPORT
JOINT EVENT, MARKETING AND COMMUNICATION ACTIVITIES
CONNECTION OPPORTUNITIES AMONG HIKVISION NETWORK
HIKVISION SOLUTION WEBSITE LISTING & RECOMMENDATIONS



BUILDINGS



SAFE CITIES



TRAFFIC



RETAIL



PERIMETER



POLICE
ENFORCEMENT



GREATER PARTNERSHIPS

Hikvision is pleased to introduce an exclusive, invitation-only Partner Program. We are committed to investing in our installer partners with a focus on capitalisation of project opportunities. Partner with Hikvision and leverage our unique market position as the leading video product manufacturer in the world, while gaining the benefits of an invitation-only program.

From inside sales to engineering support, from customer service to technical support, Hikvision goes the extra mile to provide customers with all of the elements they need for a first-class security system. Hikvision's Dealer Partner Program provides additional resources for dealers to help promote business success through knowledge and valuable tools. Hikvision is committed to protecting and creating business value for its customers.

To learn more about the program, please contact us at partners.eu@hikvision.com

www.magazijnrichtingshop.nl - info@magazijnrichtingshop.nl - tel. +31(0)26-3633683

VERTICAL MARKET FOCUS

For a complete overview of all verticals, please visit www.hikvision.com

TRANSPORTATION

Hikvision offers a wide assortment of solutions to meet the needs of transport hubs, roads, highways, and more. Effects of exhaust, sand, winter salt, snow, sleet and high winds are not an issue for Hikvision cameras, which are highly rated and made to resist severe outdoor conditions.

HEALTHCARE

Patient monitoring, emergency rooms, pharmacies, speciality departments, and restricted areas are all critical zones that require reliable security equipment. Just as we all depend on our physician to keep us well, we can depend on Hikvision's solutions to ensure the security of healthcare facilities.

EDUCATION

Protection of loved ones is one of Hikvision's highest priorities. Budget-minded school districts find Hikvision's product selection unmatched in the industry. High resolution cameras offer excellent image quality for a market-leading price. Image enhancements, such as wide dynamic range and high definition video, make our products well suited to capture remarkable detail in exterior and interior settings.

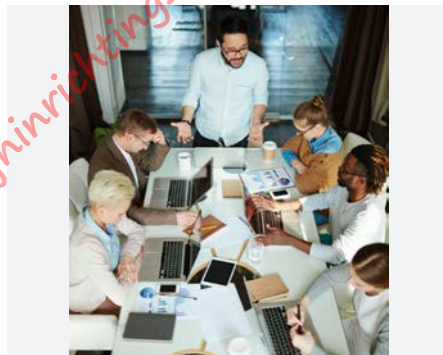

RETAIL

Shop and restaurant owners have peace of mind when using Hikvision's high performing products, which are aesthetically pleasing to boot. In each camera category are compact bullet, turret, dome and covert varieties, which provide discreet surveillance in attractive packaging. POS integration, heat mapping, and special counting cameras provide significant business management information. Data collected can then be managed through Hikvision's smart recording equipment.

GOVERNMENT

With strained budgets and changing priorities, safety remains an important issue for government facilities. Significant upgrades to existing analogue infrastructures are possible using our TurboHD™ line of HD-TVI solutions, which deliver HD analogue video without the high costs of networked systems.

SAFE CITIES

Hikvision is dedicated to helping solve public safety issues by providing surveillance systems that address emergency response, disaster management, and overall public safety. A key responsibility of any city is to ensure the safety of its citizens.



CRITICAL INFRASTRUCTURE

Hikvision's Smart Series and Speciality cameras offer performance and features that are ideal for critical security installations. Resolutions of 12 MP, 8 MP (4K), 6 MP and more deliver detailed video images. Darkfighter and Lightfighter solutions provide clear images in any lighting condition. Stainless-steel, high impact and weather-rated cameras withstand harsh environments. Built-in smart analytics provide pre- and post-event details. Data recording and storage products keep records safe and ready for forensic research. Every critical infrastructure setting has its own set of needs, and with Hikvision products, and these needs are all met.

www.magazijninrichtingshop.nl - info@magazijninrichtingshop.nl - +31(0)26-3633683



DARKFIGHTER 

DARKFIGHTER ULTRA LOW-LIGHT CAMERAS

Advanced smart features enable Hikvision's new IP Darkfighter cameras to provide exceptionally sharp images even in low-light conditions, whether during the day or at night. Combining outstanding performance and wide range with convenience and ease of use, these sophisticated cameras are taking video surveillance to an entirely new level - the ideal security choice for warehouses, retail outlets, airports, and other sensitive sites.

www.magazijninrichtingshop.nl - info@magazijninrichtingshop.nl - tel. +31(0)26-3633683

DARKFIGHTER GIVES YOU ALL THE DETAILS

EVEN IN THE DARK

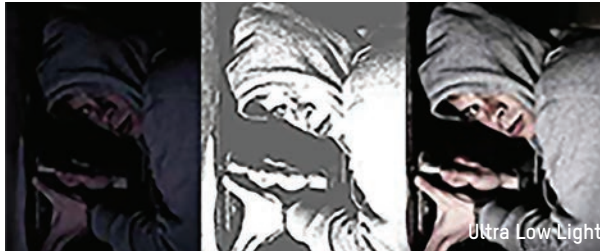

Footage registered by conventional surveillance cameras in low-light conditions is often of little value due to the diminished quality, detail and colours of images. Darkfighter cameras are equipped with 1/2" CMOS progressive scan sensors enabling them to obtain high quality images with good colour value in light levels as low as 0.002 lux, which the human eye perceives as total darkness. Darkfighter cameras are ideal for inconspicuous night time surveillance- their high sensitivity makes additional light sources unnecessary.

DARKFIGHTER IS SMART SURVEILLANCE

FOR SUPERIOR SECURITY IN ANY SITUATION



Sometimes image quality isn't enough, especially when it comes to special applications and security for high risk sites. Surveillance cameras often require sophisticated analytical capabilities to ensure they discriminate threats accurately and work reliably in any kind of situation. Features like Smart Defog, Smart Face Detection, Smart Audio Detection, Smart Intrusion Detection, Smart Line Crossing Detection and Smart Video Quality Diagnoses make Darkfighter cameras exceptionally intelligent and able to meet even the most challenging requirements.

DETAILED, HIGH-DEFINITION IMAGES

DARKFIGHTER DELIVERS 2 MP FULL HD RESOLUTION



No other camera can match Darkfighter's combination of advanced analytical capabilities, superior performance in challenging conditions and megapixel HD resolution (1920X1080 at 50fps). And that's not all. Darkfighter cameras also feature the Smart Dynamic Rol (Region of Interest) codec, which focuses encoding on a predefined area. Since they save the highest resolution images for the details that really matter, Darkfighter cameras are able to make the most out of two megapixels. Combined, these features make up a camera that has set a new benchmark for professional video surveillance technology.



DEEPER INTELLIGENCE. DEEPER SURVEILLANCE. HIKVISION'S DEEP LEARNING THE NEXT STEP IN SECURITY

Hikvision is looking to the future with the development of new technologies and capabilities, based on the Deep Learning technology that is sweeping through the video surveillance industry. Exciting new capabilities like recognising human behaviours and identifying car models are already possible with our new Hikvision products. And that's not all - Hikvision developers are constantly working to push the boundaries further!



Facial
Detection



False Alarm
Filter



People
Counting



Vehicle
Identification



Human Body
Recognition



HIKVISION THERMAL CAMERAS SEEING THE UNSEEN

All objects with a temperature above absolute zero emit thermal radiation, even at low levels. This kind of radiation, invisible to the human eye, can be detected by thermal imaging sensors. Thermal cameras can produce images in the visual spectrum by detecting temperature differences between an object and its surroundings. The larger the difference, the bigger the contrast variety, making details visible. Compared to visible-light cameras, thermal cameras can be used for applications in more challenging environments.

 smart 2.0

www.magazijninrichtingshop.nl

tel. +31(0)26-3633683

EasyIP 3.0



EasyIP 3.0 SOLUTION SIMPLE AND POWERFUL THE EASIER JOURNEY TO BETTER SECURITY

Video surveillance does not have to be complex. Technological advancements in every corner of our lives is becoming more and more simplified and user friendly. And it's true in security, too. What makes the best security system? The right components in the right places. And for the small to medium sized business with budget and time restrictions, Hikvision has got the right solution. The EasyIP 3.0 Solution. For those who know the earlier EasyIP versions, this is the go-to, out-of-the-box system. It gets the job done with stable, reliable components and advanced features from the industry's number one worldwide solutions provider.

The EasyIP 3.0 Solution from Hikvision is truly the easier way to better security. Keep reading to see all the benefits EasyIP offers.



IP CAMERAS

Hikvision has a wide range of IP cameras that bring intelligence, efficiency and varied specifications to a wide range of vertical applications.

Cutting-edge features, like DarkFighter technology and Hikvision's unique H.265+ compression codec provide outstanding image quality, even in challenging lighting environments. Camera form factors vary from box cameras, indoor and outdoor domes and bullets – right up to anti-corrosion, panoramic and people counting cameras.

The cameras are split into four areas: the Solution Series, aimed at equipping customers for a full solution; the Project Series, which provides high-quality, scalable cameras for even the most challenging project; the Economic Series for those with limited budgets and the ANPR Series for traffic solutions.

www.magazijninrichtingshop.nl - info@magazijninrichtingshop.nl - tel. +31(0)26-3633683

VARI-FOCAL BULLET CAMERA



Short Description	2 MP EXIR VF Bullet Network Camera	4 MP EXIR VF Bullet Network Camera	2 MP IR VF Bullet Network Camera	4 MP IR VF Bullet Network Camera	6 MP IR VF Bullet Network Camera
Model	DS-2CD162360-IZ	DS-2CD164360-IZ	DS-2CD262360-IZS	DS-2CD264360-IZS	DS-2CD266360-IZS
Image Sensor	1/2.8" Progressive Scan CMOS	1/3" Progressive Scan CMOS	1/2.8" Progressive Scan CMOS	1/3" Progressive Scan CMOS	1/2.9" Progressive Scan CMOS
Min. Illumination(Color)	Color: 0.01 Lux @(F1.2, AGC ON), 0.018 Lux @(F1.6, AGC ON)	Color: 0.01 Lux @(F1.2, AGC ON), 0.018 Lux @(F1.6, AGC ON)	Color: 0.01 Lux @(F1.2, AGC ON), 0.018 Lux @(F1.6, AGC ON), 0 Lux with IR	Color: 0.01 Lux @(F1.2, AGC ON), 0.018 Lux @(F1.6, AGC ON), 0 Lux with IR	Color: 0.01 Lux @(F1.2, AGC ON), 0.018 Lux @(F1.6, AGC ON), 0 Lux with IR
Lens option	2.8-12 mm	2.8-12 mm	Horizontal FOV: 110° to 31°, vertical FOV: 58° to 18°, diagonal FOV: 136° to 36°	2.8-12mm	2.8-12mm
Horizontal Angle of View	98° to 34°	98° to 28°	Horizontal FOV: 110° to 31°, vertical FOV: 58° to 18°, diagonal FOV: 136° to 36°	Horizontal FOV: 98° to 28°, vertical FOV: 51° to 16°, diagonal FOV: 115° to 32°	Horizontal FOV: 88° to 27°
Video Compression	Main stream: H.265/H.264 Sub stream: H.265/H.264/MJPEG	Main stream: H.265/H.264 Sub stream: H.265/H.264/MJPEG	Main stream: H.265/H.264, Sub-stream: H.265/H.264/MJPEG, Third stream: H.265/H.264	Main stream: H.265/H.264,Sub-stream: H.265/H.264/MJPEG,Third stream: H.265/H.264	Main stream: H.265/H.264,Sub-stream: H.265/H.264/MJPEG,Third stream: H.265/H.264
Max. Image Resolution	1920 × 1080	2560 × 1440	1920 × 1080	2560 × 1440	3072 × 2048
WDR	Digital WDR	120dB	120dB	120dB	120dB
Operations Conditions	Temperature:-30 °C to 60 °C [-22 °F to 140 °F], humidity: 95% or less (non-condensing)	Temperature:-30 °C to 60 °C [-22 °F to 140 °F], humidity: 95% or less (non-condensing)	Temperature:-30 °C to +60 °C [-22 °F to +140 °F], Humidity 95% or less (non-condensing)	Temperature:-30 °C to +60 °C [-22 °F to +140 °F], Humidity 95% or less (non-condensing)	Temperature:-30 °C to +60 °C [-22 °F to +140 °F], Humidity 95% or less (non-condensing)
Power Supply	12 VDC ± 20%, 5.5 mm coaxial power plug PoE (802.3af, class 3)	12 VDC ± 20%, 5.5 mm coaxial power plug PoE (802.3af, class 3)	12 VDC ± 25%, terminal block, PoE (802.3at, class 4)	12 VDC ± 25%, terminal block,PoE (802.3at, class 4)	12 VDC ± 25%, terminal block,PoE (802.3at, class 4)
Consumption	12 VDC, 0.9 A, max. 11 W; PoE: (802.3af, 36 V to 57 V), 0.4 A to 0.2 A, max. 12.9 W	12 VDC, 0.9 A, max. 11 W; PoE: (802.3af, 36 V to 57 V), 0.4 A to 0.2 A, max. 12.9 W	12 VDC, 1.2A, max. 14.5W;PoE (802.3at, 42.5V to 57V), 0.43A to 0.3A, max. 18W	12 VDC, 1.2A, max. 14.5W;PoE (802.3at, 42.5V to 57V), 0.43A to 0.3A, max. 18W	12 VDC, 1.2A, max. 14.5W;PoE (802.3at, 42.5V to 57V), 0.43A to 0.3A, max. 18W
IR Range	Up to 30 m	Up to 30 m	Up to 50 m	Up to 50 m	Up to 50 m
Weatherproof	IP67	IP67	IP67	IP67	IP67
Protection level	-	-	IK10	IK10	IK10
Audio Input/Output	-	-	-	-	-
Alarm Input/Output	-	-	-	-	-

www.magazijninrichtingshop.nl - info@magazijninrichtingshop.nl - tel: 020-3633083

FIXED BULLET CAMERA



NEW



NEW



NEW

Short Description	8 MP IR VF Bullet Network Camera	2 MP IR Network Bullet Camera	4 MP IR Network Bullet Camera	2 MP IR Fixed Bullet Network Camera	4 MP IR Fixed Bullet Network Camera
Model	DS-2CD268360-IZS	DS-2CD102360-I	DS-2CD104360-I	DS-2CD2T2360-I5/I8	DS-2CD2T4360-I5/I8
Image Sensor	1/2.5" Progressive Scan CMOS	1/2.8" progressive scan CMOS	1/3" progressive scan CMOS	1/2.8" Progressive Scan CMOS	1/3" Progressive Scan CMOS
Min. Illumination(Color)	Color: 0.01 Lux @ (F1.2, AGC ON), 0.018 Lux @ (F1.6, AGC ON), 0 Lux with IR	Color: 0.01 Lux @ (F1.2, AGC ON), 0.028 Lux @ (F2.0, AGC ON)	Color: 0.01 Lux @ (F1.2, AGC ON), 0.028 Lux @ (F2.0, AGC ON)	Color: 0.01 Lux @ (F1.2, AGC ON), 0.028 Lux @ (F2.0, AGC ON), 0 Lux with IR	Color: 0.01 Lux @ (F1.2, AGC ON), 0.018 Lux @ (F1.6, AGC ON), 0 Lux with IR
Lens option	2.8-12mm	2.8mm	2.8mm	2.8mm	2.8mm
Horizontal Angle of View	Horizontal FOV: 105° to 34.5°	Horizontal FOV 103°, vertical FOV 59°, diagonal FOV 118°	Horizontal FOV 100°, vertical FOV 55°, diagonal FOV 117°	Horizontal FOV: 114°, vertical FOV: 62°, diagonal FOV: 135°	Horizontal FOV: 98°, vertical FOV: 55°, diagonal FOV: 114°
Video Compression	Main stream: H.265/H.264,Sub-stream: H.265/H.264/MJPEG,Third stream: H.265/H.264	Main stream: H.265/H.264Sub stream: H.265/H.264/MJPEG	Main stream: H.265/H.264Sub stream: H.265/H.264/MJPEG	Main stream: H.265/H.264,Sub-stream: H.265/H.264/MJPEG,Third stream: H.265/H.264	Main stream: H.265/H.264,Sub-stream: H.265/H.264/MJPEG,Third stream: H.265/H.264
Max. Image Resolution	3840 × 2160	1920 × 1080	2560 × 1440	1920 × 1080	2560 × 1440
WDR	120dB	Digital WDR	Digital WDR	120dB	120dB
Operations Conditions	Temperature:-30 °C to +60 °C [-22 °F to +140 °F], Humidity 95% or less (non-condensing)	Temperature:-30 °C to 50 °C [-22 °F to 122 °F], Humidity: 95% or less (non-condensing)	Temperature:-30 °C to 50 °C [-22 °F to 122 °F], Humidity: 95% or less (non-condensing)	Temperature:-30 °C to +60 °C [-22 °F to +140 °F], Humidity 95% or less (non-condensing)	-30 °C to +60 °C [-22 °F to +140 °F], Humidity 95% or less (non-condensing)
Power Supply	12 VDC ± 25%, terminal block,PoE (802.3at, class 4)	12 VDC ± 25%, 5.5 mm coaxial power plugPoE (802.3af, class 3)	12 VDC ± 25%, 5.5 mm coaxial power plugPoE (802.3af, class 3)	12 VDC ± 25%, Φ 5.5 mm coaxial power plug,PoE (802.3af, class 3)	12 VDC ± 25%, Φ 5.5 mm coaxial power plug,PoE (802.3af, class 3)
Consumption	12 VDC, 1.2A, max. 14.5W;PoE (802.3at, 42.5V to 57V), 0.43A to 0.3A, max. 18W	12 VDC, 0.4 A, Max: 5 WPoE: (802.3af, 36 V to 57 V), 0.2 A to 0.13 A, Max: 7 W	12 VDC, 0.4 A, Max: 5 WPoE: (802.3af, 36 V to 57 V), 0.2 A to 0.13 A, Max: 7 W	12 VDC, 0.6A, max. 7.5W,PoE (802.3af, 37V to 57V), 0.2A to 0.1A, max. 9.5W	12 VDC, 0.6A, max. 7.5W,PoE (802.3af, 37V to 57V), 0.2A to 0.1A, max. 9.5W
IR Range	Up to 50 m	Up to 30 m	Up to 30 m	Up to 50 m	Up to 50 m
Weatherproof	IP67	IP67	IP67	IP67	IP67
Protection level	IK10	-	-	-	-
Audio Input/Output	-	-	-	-	-
Alarm Input/Output	-	-	-	-	-

www.magazijninrichtingshop.nl - info@magazijninrichtingshop.nl - tel: 020-3633083

VARI-FOCAL DOME CAMERA



NEW



NEW



NEW

Short Description	6 MP IR Fixed Bullet Network Camera	8 MP IR Fixed Bullet Network Camera	2 MP VF Network Bullet Camera	4 MP VF Network Bullet Camera	2 MP IR VF Dome Network Camera
Model	DS-2CD2T6360-I5/I8	DS-2CD2T8360-I5/I8	DS-2CD172360-IZ	DS-2CD174360-IZ	DS-2CD272360-IZS
Image Sensor	1/2.9" Progressive Scan CMOS	1/2.9" Progressive Scan CMOS	1/2.8" progressive scan CMOS	1/3" progressive scan CMOS	1/2.8" Progressive Scan CMOS
Min. Illumination(Color)	Color: 0.01 lux @(F1.2, AGC ON), 0.028 lux @(F2.0, AGC ON), 0 lux with IR	Color: 0.01 lux @(F1.2, AGC ON), 0.028 lux @(F2.0, AGC ON), 0 lux with IR	Color: 0.01 Lux @(F1.2, AGC ON), 0.018Lux @(F1.6, AGC ON)	Color: 0.01 Lux @(F1.2, AGC ON), 0.018 Lux @(F1.6, AGC ON)	Color: 0.01 Lux @(F1.2, AGC ON), 0.018 Lux @(F1.6, AGC ON), 0 Lux with IR
Lens option	2.8mm	2.8mm	2.8-12 mm	2.8-12 mm	2.8 to 12 mm
Horizontal Angle of View	Horizontal FOV: 97°	Horizontal FOV: 102°	98° to 34°	98° to 28°	Horizontal FOV: 110° to 31°, vertical FOV: 58° to 18°, diagonal FOV: 136° to 36°
Video Compression	Main stream: H.265/H.264,Sub-stream: H.265/H.264/MJPEG,Third stream: H.265/H.264	Main stream: H.265/H.264,Sub-stream: H.265/H.264/MJPEG,Third stream: H.265/H.264	Main stream: H.265/H.264Sub stream: H.265/H.264/MJPEG	Main stream: H.265/H.264Sub stream: H.265/H.264/MJPEG	Main stream: H.265/H.264, Sub-stream: H.265/H.264/MJPEG,Third stream: H.265/H.264
Max. Image Resolution	3072 × 2048	3840 × 2160	1920 × 1080	2560 × 1440	1920 × 1080
WDR	120dB	120dB	Digital WDR	120dB	120dB
Operations Conditions	-30 °C to +60 °C (-22 °F to +140 °F), Humidity 95% or less (non-condensing)	-30 °C to +60 °C (-22 °F to +140 °F), Humidity 95% or less (non-condensing)	Temperature:-30 °C to 50 °C (-22 °F to 122 °F), Humidity: 95% or less (non-condensing)	Temperature:-30 °C to 50 °C (-22 °F to 122 °F), Humidity: 95% or less (non-condensing)	Temperature:-30 °C to +60 °C (-22 °F to +140 °F), Humidity 95% or less (non-condensing)
Power Supply	12 VDC ± 25%, Φ 5.5 mm coaxial power plug,PoE (802.3af, class 3)	12 VDC ± 25%, Φ 5.5 mm coaxial power plug,PoE (802.3af, class 3)	12 VDC ± 20%, 5.5 mm coaxial power plugPoE (802.3af, class 3)	12 VDC ± 20%, 5.5 mm coaxial power plugPoE (802.3af, class 3)	12 VDC ± 25%, terminal block; PoE (802.3af, class 3)
Consumption	I5: 12 VDC, 0.6 A, max. 7W PoE: (802.3af, 36V to 57V), 0.3 A to 0.2 A, max. 8.5W I8: 12 VDC, 0.9 A, max. 10W PoE: (802.3af, 36V to 57V), 0.4 A to 0.2 A, max. 12W	I5: 12 VDC, 0.7 A, max. 7.5W PoE: (802.3af, 36V to 57V), 0.3 A to 0.2 A, max. 9W I8: 12 VDC, 0.9 A, max. 11W PoE: (802.3af, 36V to 57V), 0.4 A to 0.2 A, max. 12.9W	12 VDC, 0.8 A, Max: 10 W; PoE: (802.3af, 36 V to 57 V), 0.35 A to 0.2 A, Max: 12 W	12 VDC, 0.8 A, Max: 10 W; PoE: (802.3af, 36 V to 57 V), 0.35 A to 0.2 A, Max: 12 W	12 VDC, 0.8A, max. 10W;PoE (802.3af, 37V to 57V), 0.35A to 0.2A, max. 12W
IR Range	I5: up to 50 m I8: up to 80 m	I5: up to 50 m I8: up to 80 m	Up to 30 m	Up to 30 m	Up to 30 m
Weatherproof	IP67	IP67	IP67	IP67	IP67
Protection level	-	-	IK10	IK10	IK10
Audio Input/Output	-	-	-	-	-
Alarm Input/Output	-	-	-	-	-

www.magazijninrichtingshop.nl - info@magazijninrichtingshop.nl - tel: +31(0)26-3633683

FIXED DOME CAMERA



NEW



NEW



NEW

Short Description	4 MP IR VF Dome Network Camera	6 MP IR VF Dome Network Camera	2 MP IR Network Dome Camera	4 MP IR Network Dome Camera	2 MP IR Fixed Dome Network Camera
Model	DS-2CD274360-IZS	DS-2CD276360-IZS	DS-2CD112360-I	DS-2CD114360-I	DS-2CD212360-I
Image Sensor	1/3" Progressive Scan CMOS	1/2.9" Progressive Scan CMOS	1/2.8" progressive scan CMOS	1/3" progressive scan CMOS	1/2.8" Progressive Scan CMOS
Min. Illumination(Color)	Color: 0.01 Lux @ (F1.2, AGC ON), 0.018 Lux @ (F1.6, AGC ON), 0 Lux with IR	Color: 0.01 Lux @ (F1.2, AGC ON), 0.018 Lux @ (F1.6, AGC ON), 0 Lux with IR	Color: 0.01 Lux @ (F1.2, AGC ON), 0.028Lux @ (F2.0, AGC ON)	Color: 0.01 Lux @ (F1.2, AGC ON), 0.028Lux @ (F2.0, AGC ON)	Color: 0.01 Lux @ (F1.2, AGC ON), 0.028 Lux @ (F2.0, AGC ON), 0 Lux with IR
Lens option	2.8-12mm	2.8-12mm	2.8mm	2.8mm	2.8mm
Horizontal Angle of View	Horizontal FOV: 98° to 28°, vertical FOV: 51° to 16°, diagonal FOV: 115° to 32°	Horizontal FOV: 88° to 27°	Horizontal FOV 114°, vertical FOV 62°, diagonal FOV 135°	Horizontal FOV 100°, vertical FOV 55°, diagonal FOV 117°	2.8 mm: Horizontal FOV: 114°, vertical FOV: 62°, diagonal FOV: 135°
Video Compression	Main stream: H.265/H.264, Sub-stream: H.265/H.264/MJPEG, Third stream: H.265/H.264	Main stream: H.265/H.264, Sub-stream: H.265/H.264/MJPEG, Third stream: H.265/H.264	Main stream: H.265/H.264 Sub stream: H.265/H.264/MJPEG	Main stream: H.265/H.264 Sub stream: H.265/H.264/MJPEG	Main stream: H.265/H.264,Sub-stream: H.265/H.264/MJPEG,Third stream: H.265/H.264
Max. Image Resolution	2560 × 1440	3072 × 2048	1920 × 1080	2560 × 1440	1920 × 1080
WDR	120dB	120dB	Digital WDR	Digital WDR	120dB
Operations Conditions	Temperature:-30 °C to +60 °C [-22 °F to +140 °F], Humidity 95% or less (non-condensing)	Temperature:-30 °C to +60 °C [-22 °F to +140 °F], Humidity 95% or less (non-condensing)	Temperature:-30 °C to 50 °C [-22 °F to 122 °F], Humidity: 95% or less (non-condensing)	Temperature:-30 °C to 50 °C [-22 °F to 122 °F], Humidity: 95% or less (non-condensing)	Temperature:-30 °C to +60 °C [-22 °F to +140 °F], Humidity 95% or less (non-condensing)
Power Supply	12 VDC ± 25%, terminal block,PoE (802.3af, class 3)	12 VDC ± 25%, terminal block,PoE (802.3af, class 3)	12 VDC ± 25%, 5.5 mm coaxial power plug PoE (802.3af, class 3)	12 VDC ± 25%, 5.5 mm coaxial power plug PoE (802.3af, class 3)	12 VDC ± 25%, Φ 5.5 mm coaxial power plug,PoE (802.3af, class 3)
Consumption	12 VDC, 0.8A, max. 10W;PoE (802.3af, 37V to 57V), 0.35A to 0.2A, max. 12W	12 VDC, 0.8A, max. 10W;PoE (802.3af, 37V to 57V), 0.35A to 0.2A, max. 12W	12 VDC, 0.4 A, Max: 5 W PoE: (802.3af, 36 V to 57 V), 0.2 A to 0.13 A, Max: 7 W	12 VDC, 0.4 A, Max: 5 W PoE: (802.3af, 36 V to 57 V), 0.2 A to 0.13 A, Max: 7 W	12 VDC, 0.5A, max. 6W,PoE (802.3af, 37V to 57V), 0.2A to 0.1A, max. 7.5W
IR Range	Up to 30 m	Up to 30 m	Up to 30 m	Up to 30 m	Up to 30 m
Weatherproof	IP67	IP67	IP67	IP67	IP67
Protection level	IK10	IK10	IK10	IK10	IK10
Audio Input/Output	-	-	-	-	-
Alarm Input/Output	-	-	-	-	-

www.magazijninrichtingshop.nl - info@magazijninrichtingshop.nl - tel: 020-3633683



NEW



NEW



NEW

FIXED MINI DOME CAMERA



NEW



NEW

Short Description	4 MP IR Fixed Dome Network Camera	6 MP IR Fixed Dome Network Camera	8 MP IR Fixed Dome Network Camera	2 MP EXIR Fixed Mini Dome Network Camera	4 MP EXIR Fixed Mini Dome Network Camera
Model	DS-2CD214360-I	DS-2CD216360-I	DS-2CD218360-I	DS-2CD252360-IS	DS-2CD254360-IS
Image Sensor	1/3" Progressive Scan CMOS	1/2.9" Progressive Scan CMOS	1/2.5" Progressive Scan CMOS	1/2.7" Progressive Scan CMOS	1/3" Progressive Scan CMOS
Min. Illumination(Color)	Color: 0.01 Lux @ (F1.2, AGC ON), 0.018 Lux @ (F1.6, AGC ON), 0 Lux with IR	Color: 0.01 lux @ (F1.2, AGC ON), 0.028 lux @ (F2.0, AGC ON), 0 lux with IR	Color: 0.01 Lux @ (F1.2, AGC ON), 0.018 Lux @ (F1.6, AGC ON), 0 Lux with IR	Color: 0.01 Lux @ (F1.2, AGC ON), 0.018 lux @ (F1.6, AGC ON), 0 lux with IR	Color: 0.01 Lux @ (F1.2, AGC ON), 0.018 lux @ (F1.6, AGC ON), 0 lux with IR
Lens option	2.8mm	2.8mm	2.8mm	2.8mm	2.8mm
Horizontal Angle of View	2.8 mm: Horizontal FOV: 98°, vertical FOV: 55°, diagonal FOV: 114°	Horizontal FOV: 97°	Horizontal FOV: 102°	Horizontal FOV: 114°	Horizontal FOV: 98°
Video Compression	Main stream: H.265/H.264, Sub-stream: H.265/H.264/MJPEG, Third stream: H.265/H.264	Main stream: H.265/H.264, Sub-stream: H.265/H.264/MJPEG, Third stream: H.265/H.264	Main stream: H.265/H.264, Sub-stream: H.265/H.264/MJPEG, Third stream: H.265/H.264	Main stream: H.265/H.264 Sub stream: H.265/H.264/MJPEG Third stream: H.265/H.264	Main stream: H.265/H.264 Sub stream: H.265/H.264/MJPEG Third stream: H.265/H.264
Max. Image Resolution	2560 × 1440	3072 × 2048	3840 × 2160	1920 × 1080	2688 × 1520
WDR	120dB	120dB	120dB	120dB	120dB
Operations Conditions	Temperature: -30 °C to +60 °C (-22 °F to +140 °F), Humidity 95% or less (non-condensing)	Temperature: -30 °C to +60 °C (-22 °F to +140 °F), Humidity 95% or less (non-condensing)	Temperature: -30 °C to +60 °C (-22 °F to +140 °F), Humidity 95% or less (non-condensing)	-30 °C to +60 °C (-22 °F to +140 °F), Humidity 95% or less (non-condensing)	-30 °C to +60 °C (-22 °F to +140 °F), Humidity 95% or less (non-condensing)
Power Supply	12 VDC ± 25%, Φ 5.5 mm coaxial power plug, PoE (802.3af, class 3)	12 VDC ± 25%, Φ 5.5 mm coaxial power plug, PoE (802.3af, class 3)	12 VDC ± 25%, Φ 5.5 mm coaxial power plug, PoE (802.3af, class 3)	12 VDC ± 25%, PoE (802.3af, class 3)	12 VDC ± 25%, PoE (802.3af, class 3)
Consumption	12 VDC, 0.5A, max. 6W, PoE (802.3af, 37V to 57V), 0.2A to 0.1A, max. 7.5W	12 VDC, 0.5A, max. 6W, PoE (802.3af, 37V to 57V), 0.2A to 0.1A, max. 7.5W	12 VDC, 0.5A, max. 6W, PoE (802.3af, 37V to 57V), 0.2A to 0.1A, max. 7.5W	12 VDC, 0.7A, max. 8.5W, Φ 5.5mm coaxial plug power PoE (802.3af, 36V to 57V), 0.3 A to 0.1 A, max. 10W	12 VDC, 0.7A, max. 8.5W, Φ 5.5mm coaxial plug power PoE (802.3af, 36V to 57V), 0.3 A to 0.1 A, max. 10W
IR Range	Up to 30 m	Up to 30 m	Up to 30 m	Up to 10 m	Up to 10 m
Weatherproof	IP67	IP67	IP67	IP66	IP66
Protection level	IK10	IK10	IK10	IK08	IK08
Audio Input/Output	-	1/1(-S)	1/1(-S)	2/1	-
Alarm Input/Output	-	1/1(-S)	1/1(-S)	1/1	-

www.magazijninrichtingshop.nl - info@magazijninrichtingshop.nl - tel: +31(0)26-3633083

FIXED TURRET CAMERA



FIXED MINI BULLET CAMERA



Short Description	2 MP IR Network Turret Camera	4 MP IR Network Turret Camera	2 MP IR Fixed Bullet Network Camera	4 MP IR Fixed Bullet Network Camera	6 MP IR Fixed Bullet Network Camera
Model	DS-2CD132360-I	DS-2CD134360-I	DS-2CD202360-I	DS-2CD204360-I	DS-2CD206360-I
Image Sensor	1/2.8" progressive scan CMOS	1/3" progressive scan CMOS	1/2.8" Progressive Scan CMOS	1/3" Progressive Scan CMOS	1/2.9" Progressive Scan CMOS
Min. Illumination(Color)	Color: 0.01 Lux @(F1.2, AGC ON), 0.028Lux @(F2.0, AGC ON)	Color: 0.01 Lux @(F1.2, AGC ON), 0.028Lux @(F2.0, AGC ON)	Color: 0.01 Lux @ (F1.2, AGC ON), 0.028 Lux @(F2.0, AGC ON), 0 Lux with IR	Color: 0.01 Lux @ (F1.2, AGC ON), 0.018 Lux @(F1.6, AGC ON), 0 Lux with IR	Color: 0.01 lux @(F1.2, AGC ON), 0.028 lux @(F2.0, AGC ON), 0 lux with IR
Lens option	4 mm	2.8mm	2.8mm	2.8mm	2.8mm
Horizontal Angle of View	Horizontal FOV 86°, vertical FOV 46°, diagonal FOV 102°	Horizontal FOV 100°, vertical FOV 55°, diagonal FOV 117°	2.8 mm: Horizontal FOV: 103°, vertical FOV: 59°, diagonal FOV: 118°	Horizontal FOV: 98°, vertical FOV: 55°, diagonal FOV: 114°	Horizontal FOV: 97°
Video Compression	Main stream: H.265/H.264 Sub stream: H.265/H.264/MJPEG	Main stream: H.265/H.264 Sub stream: H.265/H.264/MJPEG	Main stream: H.265/H.264,Sub-stream: H.265/H.264/MJPEG,Third stream: H.265/H.264	Main stream: H.265/H.264,Sub-stream: H.265/H.264/MJPEG,Third stream: H.265/H.264	Main stream: H.265/H.264,Sub-stream: H.265/H.264/MJPEG,Third stream: H.265/H.264
Max. Image Resolution	1920 × 1080	2560 × 1440	1920 × 1080	2560 × 1440	3072 × 2048
WDR	Digital WDR	Digital WDR	120dB	120dB	120dB
Operations Conditions	Temperature:-30 °C to 50 °C (-22 °F to 122 °F), Humidity: 95% or less (non-condensing)	Temperature:-30 °C to 50 °C (-22 °F to 122 °F), Humidity: 95% or less (non-condensing)	Temperature:-30 °C to +60 °C (-22 °F to +140 °F), Humidity 95% or less (non-condensing)	Temperature:-30 °C to +60 °C (-22 °F to +140 °F), Humidity 95% or less (non-condensing)	Temperature:-30 °C to +60 °C (-22 °F to +140 °F), Humidity 95% or less (non-condensing)
Power Supply	12 VDC ± 25%, 5.5 mm coaxial power plug PoE (802.3af, class 3)	12 VDC ± 25%, 5.5 mm coaxial power plug PoE (802.3af, class 3)	12 VDC ± 25%, Φ 5.5 mm coaxial power plug, PoE (802.3af, class 3)	12 VDC ± 25%, Φ 5.5 mm coaxial power plug,PoE (802.3af, class 3)	12 VDC ± 25%, Φ 5.5 mm coaxial power plug,PoE (802.3af, class 3)
Consumption	12 VDC, 0.4 A, Max: 5 W PoE: (802.3af, 36 V to 57 V), 0.2 A to 0.13 A, Max: 7 W	12 VDC, 0.4 A, Max: 5 W PoE: (802.3af, 36 V to 57 V), 0.2 A to 0.13 A, Max: 7 W	12 VDC, 0.5A, max. 6W,PoE (802.3af, 37V to 57V), 0.2A to 0.1A, max. 7.5W	12 VDC, 0.5A, max. 6W;PoE (802.3af, 37V to 57V), 0.2A to 0.1A, max. 7.5W	12 VDC, 0.4 A, max. 6W PoE: (802.3af, 36V to 57V), 0.2 A to 0.1 A, max. 7.5W
IR Range	Up to 30 m	Up to 30 m	Up to 30 m	Up to 30 m	Up to 30 m
Weatherproof	IP67	IP67	IP67	IP67	IP67
Protection level	-	-	-	-	-
Audio Input/Output	-	-	-	-	-
Alarm Input/Output	-	-	-	-	-

www.magazijninrichtingshop.nl - info@magazijninrichtingshop.nl - tel: 020-363083

FIXED TURRET CAMERA



Short Description	8 MP IR Fixed Bullet Network Camera	2 MP IR Fixed Turret Network Camera	4 MP IR Fixed Turret Network Camera	6 MP IR Fixed Turret Network Camera	8 MP IR Fixed Turret Network Camera
Model	DS-2CD208360-I	DS-2CD232360-I	DS-2CD234360-I	DS-2CD236360-I	DS-2CD238360-I
Image Sensor	1/2.5" Progressive Scan CMOS	1/2.8" Progressive Scan CMOS	1/3" Progressive Scan CMOS	1/2.9" Progressive Scan CMOS	1/2.5" Progressive Scan CMOS
Min. Illumination(Color)	Color: 0.01 Lux @ (F1.2, AGC ON), 0.018 Lux @ (F1.6, AGC ON), 0 Lux with IR	Color: 0.01 Lux @ (F1.2, AGC ON), 0.028 Lux @ (F2.0, AGC ON), 0 Lux with IR	Color: 0.01 Lux @ (F1.2, AGC ON), 0.018 Lux @ (F1.6, AGC ON), 0 Lux with IR	Color: 0.01 Lux @ (F1.2, AGC ON), 0.028 lux @ (F2.0, AGC ON), 0 lux with IR	Color: 0.01 Lux @ (F1.2, AGC ON), 0.018 Lux @ (F1.6, AGC ON), 0 Lux with IR
Lens option	2.8mm	2.8mm	2.8mm	2.8mm	2.8mm
Horizontal Angle of View	Horizontal FOV: 102°	Horizontal FOV: 114°, vertical FOV: 62°, diagonal FOV: 135°	2.8 mm: Horizontal FOV: 98°, vertical FOV: 55°, diagonal FOV: 114°	Horizontal FOV: 97°	Horizontal FOV: 102°
Video Compression	Main stream: H.265/H.264, Sub-stream: H.265/H.264/MJPEG, Third stream: H.265/H.264	Main stream: H.265/H.264, Sub-stream: H.265/H.264/MJPEG, Third stream: H.265/H.264	Main stream: H.265/H.264, Sub-stream: H.265/H.264/MJPEG, Third stream: H.265/H.264	Main stream: H.265/H.264, Sub-stream: H.265/H.264/MJPEG, Third stream: H.265/H.264	Main stream: H.265/H.264, Sub-stream: H.265/H.264/MJPEG, Third stream: H.265/H.264
Max. Image Resolution	3840 × 2160	1920 × 1080	2560 × 1440	3072 × 2048	3840 × 2160
WDR	120dB	3D DNR	120dB	120dB	120dB
Operations Conditions	Temperature: -30 °C to +60 °C [-22 °F to +140 °F], Humidity 95% or less (non-condensing)	Temperature: -30 °C to +60 °C [-22 °F to +140 °F], Humidity 95% or less (non-condensing)	Temperature: -30 °C to +60 °C [-22 °F to +140 °F], Humidity 95% or less (non-condensing)	Temperature: -30 °C to +60 °C [-22 °F to +140 °F], Humidity 95% or less (non-condensing)	Temperature: -30 °C to +60 °C [-22 °F to +140 °F], Humidity 95% or less (non-condensing)
Power Supply	12 VDC ± 25%, Φ 5.5 mm coaxial power plug, PoE (802.3af, class 3)	12 VDC ± 25%, Φ 5.5 mm coaxial power plug, PoE (802.3af, class 3)	12 VDC ± 25%, Φ 5.5 mm coaxial power plug, PoE (802.3af, class 3)	12 VDC ± 25%, Φ 5.5 mm coaxial power plug, PoE (802.3af, class 3)	12 VDC ± 25%, Φ 5.5 mm coaxial power plug, PoE (802.3af, class 3)
Consumption	12 VDC, 0.4 A, max. 6W PoE (802.3af, 36V to 57V), 0.2 A to 0.1 A, max. 7.5W	12 VDC, 0.5A, max. 6W, PoE (802.3af, 37V to 57V), 0.2A to 0.1A, max. 7.5W	12 VDC, 0.5A, max. 6W, PoE (802.3af, 37V to 57V), 0.2A to 0.1A, max. 7.5W	12 VDC, 0.5A, max. 6W, PoE (802.3af, 37V to 57V), 0.2A to 0.1A, max. 7.5W	12 VDC, 0.5A, max. 6W, PoE (802.3af, 37V to 57V), 0.2A to 0.1A, max. 7.5W
IR Range	Up to 30 m	Up to 30 m	Up to 30 m	Up to 30 m	Up to 30 m
Weatherproof	IP67	IP67	IP67	IP67	IP67
Protection level	-	-	-	-	-
Audio Input/Output	-	-	-	-	-
Alarm Input/Output	-	-	-	-	-

www.magazijninrichtingshop.nl - info@magazijninrichtingshop.nl - tel: 020-3633083

FIXED BULLET CAMERA



NEW

FIXED DOME CAMERA



NEW

FIXED TURRET CAMERA



NEW







CUBE CAMERA



NEW

Short Description	4 MP IR Fixed Bullet Network Camera	4 MP IR Fixed Dome Network Camera	4 MP IR Fixed Turret Network Camera	5MP Network Turret Camera	2 MP EXIR Fixed Cube Network Camera
Model	DS-2CD2045FWD-I	DS-2CD2145FWD-IS	DS-2CD2345FWD-I	DS-2CD2355FWD-I	DS-2CD2425FWD-I(W)(S)
Image Sensor	1/2.5" Progressive Scan CMOS	1/2.5" Progressive Scan CMOS	1/2.5" Progressive Scan CMOS	1/2.9" Progressive Scan CMOS	1/2.8" Progressive Scan CMOS
Min. Illumination(Color)	Color: 0.009 lux @(F1.2, AGC ON), 0.016 lux @(F1.6, AGC ON), 0 lux with IR	Color: 0.009 lux @(F1.2, AGC ON), 0.016 lux @(F1.6, AGC ON), 0 lux with IR	Color: 0.009 lux @(F1.2, AGC ON), 0.016 lux @(F1.6, AGC ON), 0 lux with IR	Color: 0.01 lux @(F1.2, AGC ON), 0 lux with IR @(F1.6, AGC ON), 0 lux with IR	Color: 0.005 Lux @ (F1.2, AGC ON), 0 Lux with IR; Color: 0.009 lux @(F1.6, AGC ON), 0 lux with IR
Lens option	2.8mm	2.8mm	2.8 mm	2,8 mm	2.8 mm
Horizontal Angle of View	Horizontal FOV:109°	Horizontal FOV:109°	Horizontal FOV:109°	81°	108°
Video Compression	Main stream: H.265/H.264Sub stream: H.265/H.264/MJPEGThird stream: H.265/H.264	Main stream: H.265/H.264Sub stream: H.265/H.264/MJPEGThird stream: H.265/H.264	Main stream: H.265/H.264Sub stream: H.265/H.264/MJPEGThird stream: H.265/H.264	Main stream: H.265/H.264Sub stream: H.265/H.264/MJPEGThird stream: H.265/H.264	Main stream: H.265/H.264Sub stream: H.265/H.264/MJPEG
Max. Image Resolution	2560 × 1440	2560 × 1440	2560 × 1440	2944 × 1656	1920 × 1080
WDR	120dB	120dB	120dB	120dB	120dB
Operations Conditions	Temperature:-30 °C to +60 °C [-22 °F to +140 °F], Humidity 95% or less (non-condensing)	Temperature:-30 °C to +60 °C [-22 °F to +140 °F], Humidity 95% or less (non-condensing)	Temperature:-30 °C to +60 °C [-22 °F to +140 °F], Humidity 95% or less (non-condensing)	-30°C +60 °C [-22 °F to +140 °F], Humidity 95% or less (non-condensing)	Temperature:-10 °C to +40 °C [14 °F to +104 °F], Humidity: 95% or less (non-condensing)
Power Supply	12 VDC ± 25%/PoE(802.3af, class 3)	12 VDC ± 25%/PoE(802.3af, class 3)	12 VDC ± 25%, PoE(802.3af, class 3)	12 VDC ± 25%/PoE(802.3af, 42.5 – 57V, class 3)	12 VDC ± 20%, PoE (802.3af, class 3)
Consumption	12 VDC, 0.5 A, max. 5.5 W PoE (802.3af, 36V to 57V), 0.2 A to 0.1 A, max. 7 W	12 VDC, 0.5 A, max. 5.5 W PoE (802.3af, 36V to 57V), 0.2 A to 0.1 A, max. 7 W	12 VDC, 0.5 A, max. 6 W PoE (802.3af, 36V to 57V), 0.3 A to 0.2 A, max. 7.5 W	-	12 VDC, 0.38A, max. 7W PoE (802.3af, 36V to 57V), 0.2 A to 0.1 A, max. 7W
IR Range	30m	30m	30m	30m	Up to 10 m
Weatherproof	IP67	IP67	IP67	IP67	-
Protection level	-	IK10	-	-	-
Audio Input/Output	-	-	-	-	1/1
Alarm Input/Output	-	-	-	-	-

www.magazijninrichtingshop.nl - info@magazijninrichtingshop.nl - tel. +31(0)26-36336833

	FIXED MINI DOME CAMERA	VARI-FOCAL BULLET CAMERA	VARI-FOCAL DOME CAMERA	VARI-FOCAL TURRET CAMERA	
					
	NEW	NEW	NEW	NEW	NEW
Short Description	2 MP EXIR Fixed Mini Dome Network Camera	4 MP IR VF Bullet Network Camera	4 MP IR VF Dome Network Camera	2 MP WDR Vari-focal Network Turret Camera	4 MP IR VF Turret Network Camera
Model	DS-2CD2525FWD-I(W)(S)	DS-2CD2645FWD-IZS	DS-2CD2745FWD-IZS	DS-2CD2H25FWD-IZS	DS-2CD2H45FWD-IZS
Image Sensor	1/2.8" Progressive Scan CMOS	1/2.5" Progressive Scan CMOS	1/2.5" Progressive Scan CMOS	1/2.8" Progressive Scan CMOS	1/2.5" Progressive Scan CMOS
Min. Illumination(Color)	Color: 0.005 Lux @ (F1.2, AGC ON), 0 Lux with IR; Color: 0.009 lux @ (F1.6, AGC ON), 0 lux with IR	Color: 0.009 lux @ (F1.2, AGC ON), 0.016 lux @ (F1.6, AGC ON), 0 lux with IR	Color: 0.009 lux @ (F1.2, AGC ON), 0.016 lux @ (F1.6, AGC ON), 0 lux with IR	Color: 0.005 Lux @ (F1.2, AGC ON), 0 Lux with IR; Color: 0.0068 Lux @ (F1.4, AGC ON), 0 Lux with IR	Color: 0.009 lux @ (F1.2, AGC ON), 0.016 lux @ (F1.6, AGC ON), 0 lux with IR
Lens option	2.8mm	2.8-12mm	2.8-12mm	2.8-12 mm	2.8-12 mm
Horizontal Angle of View	108°	Horizontal FOV: 114° to 32°	Horizontal FOV: 114° to 32°	105°-35°	Horizontal FOV: 114° to 32°
Video Compression	Main stream: H.265/H.264 Sub stream: H.265/H.264/MJPEG	Main stream: H.265+/H.265/H.264+/H.264Sub stream: H.265+/H.265/H.264+/H.264/MJPEGThird stream: H.265+/H.265/H.264+/H.264	Main stream: H.265+/H.265/H.264+/H.264Sub stream: H.265+/H.265/H.264+/H.264/MJPEGThird stream: H.265+/H.265/H.264+/H.264	Main stream: H.265+/H.265/H.264+/H.264Sub stream: H.265+/H.265/H.264+/H.264/MJPEGThird stream: H.265+/H.265/H.264+/H.264	Main stream: H.265+/H.265/H.264+/H.264Sub stream: H.265+/H.265/H.264+/H.264/MJPEGThird stream: H.265+/H.265/H.264+/H.264
Max. Image Resolution	1920 × 1080	2560 × 1440	2560 × 1440	1920 × 1080	2560 × 1440
WDR	120dB	120dB	120dB	120dB	120dB
Operations Conditions	Temperature:-30 °C to 60 °C [-22 °F to 140 °F], humidity: 95% or less (non-condensing)	Temperature:-30 °C to +60 °C [-22 °F to +140 °F], Humidity 95% or less (non-condensing)	Temperature:-30 °C to +60 °C [-22 °F to +140 °F], Humidity 95% or less (non-condensing)	-30 °C to +60 °C [-22 °F to +140 °F], Humidity 95% or less (non-condensing)	Temperature:-30 °C to +60 °C [-22 °F to +140 °F], Humidity 95% or less (non-condensing)
Power Supply	12 VDC ± 25%, PoE (802.3af, class 3)	12 VDC ± 25%, terminal block for DC input PoE(802.3at, class 4)	12 VDC ± 25%, PoE (802.3at)Terminal block for DC input	12 VDC ± 25%, PoE (802.3af)Terminal block for DC input	12 VDC ± 25%, PoE (802.3af)Terminal block for DC input
Consumption	12 VDC, 0.625A, max. 7.5W PoE (802.3af, 36V to 57V), 0.26 A to 0.17 A, max. 9.5W	12 VDC, 1.2 A, max. 14.4 W PoE (802.3at, 42.5V to 57V), 0.5 A to 0.3 A, max. 18 W	12 VDC, 1 A, max. 11 W PoE (802.3af, 36V to 57V), 0.4 A to 0.2 A, max. 12.5 W	Max. 10W	12 VDC, 1 A, max. 11 W PoE (802.3af, 36V to 57V), 0.4 A to 0.3 A, max. 12.5 W
IR Range	Up to 10 m	50m	30m	Up to 30 m	Up to 30 m
Weatherproof	IP66	IP67	IP67	IP67	IP67
Protection level	IK08	IK10	IK10	IK10	IK10
Audio Input/Output	2/1(-S)	1/1	1/1	1/1	1/1
Alarm Input/Output	1/1(-S)	1/1	1/1	1/1	1/1

www.magazijninrichtingshop.nl - info@magazijninrichtingshop.nl - 020-310263633683



FIXED BULLET CAMERA

VARI-FOCAL DOME CAMERA

Short Description	5 MP WDR Vari-focal Network Turret Camera	28MP WDR Vari-focal Network Turret Camera	4 MP IR Fixed Bullet Network Camera	8MP WDR Vari-focal Network Dome Camera	5MP WDR Vari-focal Network Dome Camera
Model	DS-2CD2H55FWD-IZS	DS-2CD2H85FWD-IZS	DS-2CD2T45FWD-IZ/IB	DS-2CD2785FWD-IZS	DS-2CD2755FWD-IZS
Image Sensor	1/2.9" Progressive Scan CMOS	1/2.5" Progressive Scan CMOS	1/2.5" Progressive Scan CMOS	1/2.9" Progressive Scan CMOS	1/2.9" Progressive Scan CMOS
Min. Illumination(Color)	Color: 0.01 Lux @ (F1.2, AGC ON), 0 Lux with IR Color: 0.014 Lux @ (F1.4, AGC ON), 0 Lux with IR	Color: 0.01 Lux @ (F1.2, AGC ON), 0 Lux with IR Color: 0.014 Lux @ (F1.4, AGC ON), 0 Lux with IR	Color: 0.009 lux @ (F1.2, AGC ON), 0.016 lux @ (F1.6, AGC ON), 0 lux with IR	Color: 0.01 Lux @ (F1.2, AGC ON), 0 Lux with IR Color: 0.014 Lux @ (F1.4, AGC ON), 0 Lux with IR	Color: 0.01 Lux @ (F1.2, AGC ON), 0 Lux with IR Color: 0.014 Lux @ (F1.4, AGC ON), 0 Lux with IR
Lens option	2.8-12 mm	2.8 -12 mm	2.8 mm	2.8-12mm	2.8-12mm
Horizontal Angle of View	88°-29°	120°-36°	Horizontal FOV:109°	120°-36°	88°-29°
Video Compression	Main stream: H.265+/H.265/H.264+/H.264Sub stream: H.265+/H.265/H.264+/H.264/MJPEGThird stream: H.265+/H.265/H.264+/H.264	Main stream: H.265+/H.265/H.264+/H.264Sub stream: H.265+/H.265/H.264+/H.264/MJPEGThird stream: H.265+/H.265/H.264+/H.264	Main stream: H.265+/H.265/H.264+/H.264Sub stream: H.265+/H.265/H.264+/H.264/MJPEGThird stream: H.265+/H.265/H.264+/H.264	Main stream: H.265+/H.265/H.264+/H.264Sub stream: H.265+/H.265/H.264+/H.264/MJPEGThird stream: H.265+/H.265/H.264+/H.264	Main stream: H.265+/H.265/H.264+/H.264Sub stream: H.265+/H.265/H.264+/H.264/MJPEGThird stream: H.265+/H.265/H.264+/H.264
Max. Image Resolution	2944 × 1656	3840 × 2160	2560 × 1440	3840 × 2160	2944 × 1656
WDR	120dB	120dB	120dB	120dB	120dB
Operations Conditions	-30 °C to +60 °C (-22 °F to +140 °F), Humidity 95% or less (non-condensing)	-30 °C to +60 °C (-22 °F to +140 °F), Humidity 95% or less (non-condensing)	Temperature: -30 °C to +60 °C (-22 °F to +140 °F), Humidity 95% or less (non-condensing)	-30 °C +60 °C (-22 °F to +140 °F), Humidity 95% or less (non-condensing)	-30 °C +60 °C (-22 °F to +140 °F), Humidity 95% or less (non-condensing)
Power Supply	12 VDC ± 25%, PoE (802.3af)Terminal block for DC input	12 VDC ± 25%, PoE (802.3af)Terminal block for DC input	12 VDC ± 25%, PoE(802.3af, class 3)	12 VDC ± 25%, PoE (802.3at)Terminal block for DC input	12 VDC ± 25%, PoE (802.3at)Terminal block for DC input
Consumption	Max. 11W	Max. 11W	I5: 12 VDC, 0.7 A, max. 7.5 W PoE (802.3af, 36V to 57V), 0.3 A to 0.1 A, max. 9.5 W I8: 12 VDC, 1 A, max: 11.5 W PoE (802.3af, 36V to 57V), 0.4 A to 0.2 A, max. 12.9 W	-	-
IR Range	Up to 30 m	Up to 30 m	I5: Up to 50 m I8: Up to 80 m	30m	30m
Weatherproof	IP67	IP67	IP67	IP67	IP67
Protection level	IK10	IK10	-	IK10	IK10
Audio Input/Output	1/1	1/1	-	1/1	1/1
Alarm Input/Output	1/1	1/1	-	1/1	1/1

www.magazijninrichtingshop.nl - info@magazijninrichtingshop.nl - Tel: +31(0)26-3633683



FIXED DOME CAMERA



FIXED TURRET CAMERA

Short Description	2MP WDR Vari-focal Network Dome Camera	8MP Network Dome Camera	5 MP Network Dome Camera	2 MP Ultra-Low Light Network Dome Camera	8MP Network Turret Camera
Model	DS-2CD2725FWD-IZS	DS-2CD2185FWD-I	DS-2CD2155FWD-I	DS-2CD2125FWD-IS	DS-2CD2385FWD-I
Image Sensor	1/2.8" Progressive Scan CMOS	1/2.5" Progressive Scan CMOS	1/2.9" Progressive Scan CMOS	1/2.8" Progressive Scan CMOS	1/2.5" Progressive Scan CMOS
Min. Illumination(Color)	Color: 0.005 Lux @ (F1.2, AGC ON), 0 Lux with IR Color: 0.0068 Lux @ (F1.4, AGC ON), 0 Lux with IR	0.01 lux @(F1.2, AGC ON), 0 lux with IR	Color: 0.01 lux @(F1.2, AGC ON), 0 lux with IR	Color: 0.005 lux @(F1.2, AGC ON), 0 lux with IR	0.01 lux @(F1.2, AGC ON), 0 lux with IR
Lens option	2.8-12mm	2.8 mm	2.8mm	2.8mm	2.8 mm
Horizontal Angle of View	105°~35°	102°	80°	108°	102°
Video Compression	Main stream: H.265+/H.265/H.264+/H.264 Sub stream: H.265+/H.265/H.264+/H.264/MJPEG Third stream: H.265+/H.265/H.264+/H.264	Main stream: H.265/H.264 Sub stream: H.265/H.264/MJPEG Third stream: H.265/H.264	Main stream: H.265/H.264 Sub stream: H.265/H.264/MJPEG Third stream: H.265/H.264	Main stream: H.265/H.264 Sub stream: H.265/H.264/MJPEG Third stream: H.265/H.264	Main stream: H.265/H.264 Sub stream: H.265/H.264/MJPEG Third stream: H.265/H.264
Max. Image Resolution	1920 × 1080	3840 × 2160	2560 × 1920	1920 × 1080	3840 × 2160
WDR	120dB	120dB	120dB	120dB	120dB
Operations Conditions	-30°C +60 °C [-22 °F to +140 °F], Humidity 95% or less (non-condensing)	-30°C – 60 °C [-22 °F – 140 °F], Humidity 95% or less (non-condensing), -H: -40 °C – 60 °C	-30 °C to +60 °C [-22 °F to +140 °F], Humidity 95% or less (non-condensing)	-30 °C to +60 °C [-22 °F to +140 °F], Humidity 95% or less (non-condensing)	-30°C +60 °C [-22 °F to +140 °F], Humidity 95% or less (non-condensing)
Power Supply	12 VDC ± 25%, PoE (802.3at) Terminal block for DC input	12 VDC ± 25%/PoE(802.3af, class 3)	12 VDC ± 25%/PoE(802.3af, class 3)	12 VDC ± 25%/PoE(802.3af, class 3)	12 VDC ± 25%/PoE(802.3af, 42.5 – 57V, class 3)
Consumption	-	-	-	-	-
IR Range	30m	30m	30m	30m	30m
Weatherproof	IP67	IP67	IP67	IP67	IP67
Protection level	IK10	IK10	IK10	IK10	-
Audio Input/Output	1/1	-	-	-	-
Alarm Input/Output	1/1	-	-	-	-

www.magazijninrichtingshop.nl - info@magazijninrichtingshop.nl - tel: +31(0)26-3633683



FISHEYE CAMERA



FIXED BULLET CAMERA



Short Description	2MP Ultra-Low Light Network Turret Camera	5MP Network Fisheye Camera	3MP Network Fisheye Camera	8MP EXIR Network Bullet Camera	5MP Network Bullet Camera
Model	DS-2CD2325FWD-I	DS-2CD2955FWD-IS	DS-2CD2935FWD-IS	DS-2CD2T85FWD-I5/18	DS-2CD2T55FWD-I8
Image Sensor	1/2.5" Progressive Scan CMOS	1/2.5" Progressive Scan CMOS	1/2.8" Progressive Scan CMOS	1/2.5" Progressive Scan CMOS	1/2.9" Progressive Scan CMOS
Min. Illumination(Color)	0.005 lux @(F1.2, AGC ON), 0 lux with IR	0.01Lux @(F1.2, AGC ON), 0 Lux with IR on	0.005Lux @(F1.2, AGC ON), 0 Lux with IR on	0.002 Lux @(F1.2, AGC ON)	0.002 Lux @(F1.2, AGC ON)
Lens option	2.8 mm	1.05 mm	1.6mm	4mm	4mm
Horizontal Angle of View	108°	180°	180°	79°	63.5°
Video Compression	Main stream: H.265/H.264Sub stream: H.265/H.264/MJPEGThird stream: H.265/H.264	Main stream: H.265/H.264Sub stream: H.265/H.264/MJPEG	Main stream: H.265/H.264Sub stream: H.265/H.264/MJPEG	Main stream: H.265/H.264Sub stream: H.265/H.264/MJPEGThird stream: H.265/H.264	Main stream: H.265/H.264Sub stream: H.265/H.264/MJPEGThird stream: H.265/H.264
Max. Image Resolution	1920 × 1080	2560 × 1920	2048 × 1536	3840 × 2160	2560 × 1920
WDR	120dB	120dB	120dB	120dB	120dB
Operations Conditions	-30°C +60 °C [-22 °F to +140 °F], Humidity 95% or less (non-condensing)	-10 °C to +50 °C [-14 °F to +122 °F], humidity 95% or less (non-condensing)	-10 °C to +50 °C [-14 °F to +122 °F], humidity 95% or less (non-condensing)	-30°C – 60 °C [-22 °F – 140 °F], Humidity 95% or less (non-condensing), -H: -40 °C – 60 °C	-30°C – 60 °C [-22 °F – 140 °F], Humidity 95% or less (non-condensing), -H: -40 °C – 60 °C
Power Supply	12 VDC ± 25%/PoE(802.3af, 42.5 – 57V, class 3)	DC 12V ± 25%, 2A,PoE(802.3af 36-57V, class 3), 0.4 – 0.7 A	DC 12V ± 25%, 2A,PoE(802.3af 36-57V, class 3), 0.4 – 0.7 A	12 VDC ± 25%; PoE	12 VDC ± 25%; PoE
Consumption	-	-	-	-	-
IR Range	30m	8m	8m	50m	50m
Weatherproof	IP67	-	-	IP67	IP67
Protection level	-	-	-	-	-
Audio Input/Output	-	1/1	1/1	-	-
Alarm Input/Output	-	1/1	1/1	-	-

www.magazijninrichtingshop.nl - info@magazijninrichtingshop.nl - tel: +31(0)26-3633683

VARI-FOCAL BULLET CAMERA



FIXED BULLET CAMERA



Short Description	8MP WDR Vari-focal Network Bullet Camera	5MP WDR Vari-focal Network Bullet Camera	2MP WDR Vari-focal Network Bullet Camera	8MP Mini Bullet Network Camera	5MP Ultra-light Mini Bullet Network Camera
Model	DS-2CD2685FWD-IZS	DS-2CD2655FWD-IZS	DS-2CD2625FWD-IZS	DS-2CD2085FWD-I	DS-2CD2055FWD-I
Image Sensor	1/2.5" Progressive Scan CMOS	1/2.8" Progressive Scan CMOS	1/2.8" Progressive Scan CMOS	1/2.5" Progressive Scan CMOS	1/2.9" Progressive Scan CMOS
Min. Illumination(Color)	Color: 0.01 Lux @ (F1.2, AGC ON), 0 Lux with IRC Color: 0.014 Lux @ (F1.4, AGC ON), 0 Lux with IR	Color: 0.005 Lux @ (F1.2, AGC ON), 0 Lux with IRC Color: 0.0089 Lux @ (F1.6, AGC ON), 0 Lux with IR	Color: 0.005 Lux @ (F1.2, AGC ON), 0 Lux with IRC Color: 0.0068 Lux @ (F1.4, AGC ON), 0 Lux with IR	0.01 lux @ (F1.2, AGC ON), 0 lux with IR	Color: 0.01 lux @ (F1.2, AGC ON), 0 lux with IR
Lens option	2.8-12mm	2.8-12mm	2.8-12mm	2.8 mm	2.8mm
Horizontal Angle of View	97°-33°	97°-33°	105°-35°	102°	81°
Video Compression	Main stream: H.265+/H.265/H.264+/H.264 Sub stream: H.265+/H.265/H.264+/H.264/MJPEG Third stream: H.265+/H.265/H.264+/H.264	Main stream: H.265+/H.265/H.264+/H.264 Sub stream: H.265+/H.265/H.264+/H.264/MJPEG Third stream: H.265+/H.265/H.264+/H.264	Main stream: H.265+/H.265/H.264+/H.264 Sub stream: H.265+/H.265/H.264+/H.264/MJPEG Third stream: H.265+/H.265/H.264+/H.264	Main stream: H.265/H.264 Sub stream: H.265/H.264/MJPEG Third stream: H.265/H.264	Main stream: H.265/H.264 Sub stream: H.265/H.264/MJPEG Third stream: H.265/H.264
Max. Image Resolution	3840 × 2160	2048 × 1536	1920 × 1080	3840 × 2160	2560 x 1920
WDR	120dB	120dB	120dB	120dB	120dB
Operations Conditions	-30°C +60 °C (-22 °F to +140 °F), Humidity 95% or less (non-condensing)	-30°C +60 °C (-22 °F to +140 °F), Humidity 95% or less (non-condensing)	-30°C +60 °C (-22 °F to +140 °F), Humidity 95% or less (non-condensing)	-30 °C to +60 °C (-22 °F to +140 °F), Humidity 95% or less (non-condensing)	-30 °C to +60 °C (-22 °F to +140 °F), Humidity 95% or less (non-condensing)
Power Supply	12 VDC ± 25%, PoE (802.3at) Terminal block for DC input	12 VDC ± 25%, PoE (802.3at) Terminal block for DC input	12 VDC ± 25%/PoE(802.3af, 42.5 – 57V, class 3)	12 VDC ± 25%/PoE(802.3af, class 3)	12 VDC ± 25%/PoE(802.3af, class 3)
Consumption	-	-	-	7W/7.5W	-
IR Range	50m	50m	30m	30m	30m
Weatherproof	IP67	IP67	IP67	IP67	IP67
Protection level	IK10	IK10	IK10	-	-
Audio Input/Output	1/1	1/1	1/1	-	-
Alarm Input/Output	1/1	1/1	1/1	-	-

www.magazijninrichtingshop.nl - info@magazijninrichtingshop.nl - tel: +31(0)26-3633683



Short Description	2MP Ultra-light Mini Bullet Network Camera
Model	DS-2CD2025FWD-I
Image Sensor	1/2.8" Progressive Scan CMOS
Min. Illumination(Color)	Color: 0.005 lux @(F1.2, AGC ON), 0 lux with IR
Lens option	2.8mm
Horizontal Angle of View	108°
Video Compression	Main stream: H.265/H.264Sub stream: H.265/H.264/MJPEGThird stream: H.265/H.264
Max. Image Resolution	1920 × 1080
WDR	120dB
Operations Conditions	-30 °C to +60 °C [-22 °F to +140 °F], Humidity 95% or less (non-condensing)
Power Supply	12 VDC ± 25% / PoE(802.3af, class 3)
Consumption	-
IR Range	30m
Weatherproof	IP67
Protection level	-
Audio Input/Output	-
Alarm Input/Output	-

www.magazijninrichtingshop.nl - info@magazijninrichtingshop.nl - tel. +31(0)26-3633683







IP PTZ CAMERAS

Hikvision PTZ Cameras provide a wide array of benefits giving customers maximum tracking and more detail. Features like true WDR, up to 50x optical zoom, an IR range of up to 200 metres DarkFighter technology, make this series

The cameras come in three ranges, for the most flexibility: the Solution Series representing top-of-the-class in video surveillance; the Project Series, for scalable professional implementation and the Economic Series, for the price sensitive market.

www.magazijninrichtingshop.nl - info@magazijninrichtingshop.nl - tel. +31(0)26-3633683

	IR INDOOR PTZ	IR OUTDOOR PTZ	INDOOR PTZ	IR OUTDOOR PTZ	OUTDOOR PTZ
					
Short Description	2MP 4×Network IR PTZ Camera	2MP 15× Network IR Speed Dome	2MP 15× Network Speed Dome	2 MP 25× Network IR Speed Dome	2 MP 25× Network Speed Dome
Model	DS-2DE2204IW-DE3(I/W)	DS-2DE4215IW-DE	DS-2DE4215W-DE3	DS-2DE4225IW-DE	DS-2DE4225W-DE
Working Temperature	-10°C to 50°C (14°F to 122°F)	Working Temperature: -30°C to 65°C (-22°F to 149°F)	Temperature: -10°C to 55°C (14°F to 131°F)	Temperature: -30°C to 65°C (-22°F to 149°F)	Outdoor Models: -30°C to 65°C (-22°F to 149°F)
Protection Level	VS 4000V Lightning Protection, Surge Protection and Voltage Transient Protection	IP66 Standard; TVS 4000V Lightning Protection, Surge Protection and Voltage Transient Protection	TVS 4000V Lightning Protection, Surge Protection and Voltage Transient Protection	IP66 Standard; TVS 4000V Lightning Protection, Surge Protection and Voltage Transient Protection	IP66 Standard, TVS 4000V Lightning Protection, Surge Protection and Voltage Transient Protection
Image Sensor	1/2.8" progressive scan CMOS	1/2.8" progressive scan CMOS	1/2.8" progressive scan CMOS	1/2.8" progressive scan CMOS	1/2.8" progressive scan CMOS
Min. Illumination	Color: 0.05 Lux @(F2.0, AGC ON) B/W: 0.005 Lux @(F2.0, AGC ON) 0 Lux with IR	Color: 0.005 Lux @(F1.6, AGC ON) B/W: 0.001 Lux @(F1.6, AGC ON) 0 Lux with IR	Color: 0.005 Lux @(F1.6, AGC ON) B/W: 0.001 Lux @(F1.6, AGC ON)	Color: 0.005 Lux @(F1.6, AGC ON) B/W: 0.001 Lux @(F1.6, AGC ON) 0 Lux with IR	Color: 0.005 Lux @(F1.6, AGC ON) B/W: 0.001 Lux @(F1.6, AGC ON)
Max. Image Resolution					
Focal Length	2.8 mm to 12 mm	5 mm to 75 mm	5 mm to 75 mm	4.8 mm to 120 mm	4.8 mm to 120 mm
Optical Zoom	4×	15×	15×	25×	25×
Angle of View	Horizontal field of view: 100° to 25° (wide-tele) Vertical field of view: 56.3° to 14.1° (wide-tele) Diagonal field of view: 114.7° to 28.7° (wide-tele)	Horizontal field of view: 53.8° to 4.0° (wide-tele) Vertical field of view: 31.9° to 2.3° (wide-tele) Diagonal field of view: 60.4° to 4.6° (wide-tele)	Horizontal field of view: 53.8° to 4.0° (wide-tele) Vertical field of view: 31.9° to 2.3° (wide-tele) Diagonal field of view: 60.4° to 4.6° (wide-tele)	Horizontal field of view: 57.6° to 2.5° (wide-tele) Vertical field of view: 34.4° to 1.4° (wide-tele) Diagonal field of view: 64.5° to 2.9° (wide-tele)	Horizontal field of view: 57.6° to 2.5° (wide-tele) Vertical field of view: 34.4° to 1.4° (wide-tele) Diagonal field of view: 64.5° to 2.9° (wide-tele)
Aperture Range	F1.8 to F2.5	F1.6 to F3.5	F1.6 to F3.5	F1.6 to F3.8	F1.6 to F3.8
Range	Pan:350°,Tilt:From 0° to 90°	Pan:360° endless;Tilt:From -15° to 90° (Auto-flip)	Pan:360°,Tilt:From 5° to 90°	Pan:360°,Tilt:From -15° to 90°	Pan:360°,Tilt:From 5° to 90°
Speed	Pan:Configurable, from 0.1°/s to 60°/s, Preset Speed: 60°/s Tilt: Configurable, from 0.1°/s to 50°/s, Preset Speed: 50°/s	Pan:Configurable, from 0.1°/s to 80°/s, Preset Speed: 80°/s; Tilt: Configurable, from 0.1°/s to 80°/s Preset Speed: 80°/s	Pan:Configurable, from 0.1°/s to 100°/s, Preset Speed: 100°/s Tilt: Configurable, from 0.1°/s to 80°/s, Preset Speed: 80°/s	Pan:Configurable, from 0.1°/s to 80°/s, Preset Speed: 80°/s Tilt: Configurable, from 0.1°/s to 80°/s, Preset Speed: 80°/s	Pan:Configurable, from 0.1°/s to 100°/s, Preset Speed: 100°/s Tilt: Configurable, from 0.1°/s to 80°/s, Preset Speed: 80°/s
IR Distance		100m			-
Alarm Input	1	-	-	2	1
Alarm Output	1	-	-	1	1
Mini SD Memory Card	Built-in memory card slot, support Micro SD/SDHC/SDXC, up to 256 GB; NAS (NPS, SMB/ CIPS), ANR	Built-in memory card slot, support Micro SD/SDHC/SDXC, up to 256 GB; NAS (NPS, SMB/ CIPS), ANR	Built-in memory card slot, support Micro SD/SDHC/SDXC, up to 256 GB; NAS (NPS, SMB/ CIPS), ANR	Built-in memory card slot, support Micro SD/SDHC/SDXC, up to 256 GB; NAS (NPS, SMB/ CIPS), ANR	Built-in memory card slot, support Micro SD/SDHC/SDXC, up to 256 GB; NAS (NPS, SMB/ CIPS), ANR
Power	12 VDC and PoE+ (802.3at, class4) Max.: 9 W (IR light 3 W Max.)	12 VDC and PoE+ (802.3at, class4) Max.: 18 W (IR light 6 W Max.)	12 VDC and PoE+ (802.3at, class4) Max.: 18 W (IR light 6 W Max.)	12 VDC & PoE+ (802.3at, class4), Max.:18 W (IR Max.6 W)	12 VDC & PoE+ (802.3at, class4), Max.:18 W
Dimensions	Φ 125 mm × 136.7 mm (Φ 4.92" × 5.38")	Φ 164.5 mm × 290 mm (Φ 6.48" × 11.42")	Φ 165 mm × 179.5 mm (Φ 6.5" × 7.1")	Φ 164.5 mm × 290 mm (Φ 6.48" × 11.42")	Φ 180 mm × 239.5 mm (Φ 7.09" × 9.43")
Weight (approx.)	Approx. 0.65 kg (1.43 lb)	Approx. 2 kg (4.41 lb)	Approx. 2 kg (4.41 lb)	Approx. 2 kg (4.41 lb)	Approx. 2 kg (4.41 lb)

www.magazijninrichtingshop.nl - info@magazijninrichtingshop.nl - 06-325026363

IR OUTDOOR PTZ



NEW

IR INDOOR PTZ







NEW



NEW

Short Description	4MP 25x Network IR Speed Dome	2MP 15x Network IR PTZ Camera	2 MP 25x Network IR PTZ Camera
Model	DS-2DE4425IW-DE	DS-2DE4A215IW-DE	DS-2DE4A225IW-DE
Working Temperature	Temperature: -30°C to 65°C (-22°F to 149°F)	Temperature: -30°C to 65°C (-22°F to 149°F)	Temperature: -30°C to 65°C (-22°F to 149°F)
Protection Level	IP66 Standard, TVS 4000V Lightning Protection, Surge Protection and Voltage Transient Protection	IP66 Standard; TVS 4000V Lightning Protection, Surge Protection and Voltage Transient Protection	IP66 Standard; TVS 4000V Lightning Protection, Surge Protection and Voltage Transient Protection
Image Sensor	1/2.5" progressive scan CMOS	1/2.8" progressive scan CMOS	1/2.8" progressive scan CMOS
Min. Illumination	Color: 0.005 Lux @(F1.6, AGC ON) B/W: 0.001Lux @(F1.6, AGC ON) 0 Lux with IR	Color: 0.005 Lux @(F1.6, AGC ON) B/W: 0.001 Lux @(F1.6, AGC ON) 0 Lux with IR	Color: 0.005 Lux @(F1.6, AGC ON) B/W: 0.001 Lux @(F1.6, AGC ON) 0 Lux with IR
Max. Image Resolution			
Focal Length	4.8 mm to 120 mm	5 mm to 75 mm	4.8 mm to 120 mm
Optical Zoom	25x	15x	15x
Angle of View	Horizontal field of view: 59.5° to 2.6° (Wide-Tele) Vertical field of view: 35.7° to 1.5° (Wide-Tele) Diagonal field of view: 66.6 to 3.0° (Wide-Tele)	Horizontal field of view: 53.8° to 4.0° (wide-tele) Vertical field of view: 31.9° to 2.3° (wide-tele) Diagonal field of view: 60.4° to 4.6°(wide-tele)	Horizontal field of view: 57.6° to 2.5° (wide-tele) Vertical field of view: 34.4° to 1.4° (wide-tele) Diagonal field of view: 64.5° to 2.9° (wide-tele)
Aperture Range	F1.6 to F3.5	F1.6 to F3.5	F1.6 to F3.8
Range	Pan:360° endless,Tilt:From -15° to 90°	Pan:360°,Tilt:From -5° to 90°	Pan:360°,Tilt:From -5° to 90°
Speed	Pan:Configurable, from 0.1°/s to 80°/s, Preset speed: 80°/s Tilt:Configurable, from 0.1°/s to 80°/s, Preset Speed: 80°/s	Pan:Configurable, from 0.1°/s to 100°/s, Preset Speed: 100°/s Tilt: Configurable, from 0.1°/s to 100°/s, Preset Speed: 100°/s	Pan:Configurable, from 0.1°/s to 300°/s, Preset Speed: 350°/s Tilt: Configurable, from 0.1°/s to 160°/s, Preset Speed: 200°/s
IR Distance		50m	50m
Alarm Input	-	-	2
Alarm Output	-	-	2
Mini SD Memory Card	Built-in memory card slot, support Micro SD/SDHC/SDXC, up to 256 GB; NAS (NPS, SMB/ CIFS), ANR	Built-in memory card slot, support Micro SD/SDHC/SDXC, up to 256 GB; NAS (NPS, SMB/ CIFS); ANR	Built-in memory card slot, support Micro SD/SDHC/SDXC, up to 256 GB; NAS (NPS, SMB/ CIFS), ANR
Power	12 VDC and PoE+ (802.3 at, class4) Max.: 18 W (Max. 7W for IR)	12 VDC and PoE+ (802.3at, class4) Max.: 18 W (IR light 5 W Max.)	12 VDC & PoE+ (802.3at, class4), Max.:18 W (IR Max.5 W)
Dimensions	Φ 164.5 mm × 290 mm (Φ 6.48" × 11.42")	Φ 169 mm × 161 mm (Φ 6.65" × 6.34")	Φ 169 mm × 161 mm (Φ 6.65" × 6.34")
Weight (approx.)	Approx. 2 kg (4.41 lb)	Approx. 2.45 kg (5.40 lb)	Approx. 2.45 kg (5.40 lb)

www.magazijn.nl - info@magazijn.nl - tel. +31(0)26-3633683

	IR OUTDOOR PTZ  NEW	OUTDOOR PTZ  NEW	 NEW	IR OUTDOOR PTZ  NEW	 NEW
Short Description	2 MP 25× Network IR Speed Dome	2 MP 25× Network Speed Dome	2MP 32× Network Speed Dome	2 MP 25× Network IR Speed Dome	2 MP 32× Network IR Speed Dome
Model	DS-2DE5225IW-AE	DS-2DE5225W-AE	DS-2DE5232W-AE	DS-2DE7225IW-AE	DS-2DE7232IW-AE
Working Temperature	Temperature:-30°C to 65°C [-22°F to 149°F]	Temperature:-30°C to 65°C [-22°F to 149°F]	Temperature: -30°C to 65°C [-22°F to 149°F]	Temperature:-30°C to 65°C [-22°F to 149°F]	Temperature:-30°C to 65°C [-22°F to 149°F]
Protection Level	IP66 Standard, TVS 4000V Lightning Protection, Surge Protection and Voltage Transient Protection	IP66 Standard, TVS 4000V Lightning Protection, Surge Protection and Voltage Transient Protection	IP66 Standard, TVS 4000V Lightning Protection, Surge Protection and Voltage Transient Protection	IP66 Standard, TVS 4000V Lightning Protection, Surge Protection and Voltage Transient Protection	IP66 Standard, TVS 4000V Lightning Protection, Surge Protection and Voltage Transient Protection
Image Sensor	1/2.8" progressive scan CMOS	1/2.8" progressive scan CMOS	1/2.8" Progressive scan CMOS	1/2.8" progressive scan CMOS	1/2.8" progressive scan CMOS
Min. Illumination	Color: 0.005 Lux @(F1.6, AGC ON) B/W: 0.001 Lux @(F1.6, AGC ON)	Color: 0.005 Lux @(F1.6, AGC ON) B/W: 0.001 Lux @(F1.6, AGC ON)	Color: 0.005 Lux @(F1.6, AGC ON) B/W: 0.001Lux @(F1.6, AGC ON)	Ultra-low light: Color: 0.005 Lux @(F1.5, AGC ON) B/W: 0.001 Lux @(F1.5, AGC ON) 0 Lux with IR	Ultra-low light: Color: 0.005 Lux @(F1.5, AGC ON) B/W: 0.001 Lux @(F1.5, AGC ON) 0 Lux with IR
Max. Image Resolution			1920×1080		
Focal Length	4.8 mm to 120 mm	4.8 mm to 120 mm	4.8 mm to 153 mm	4.8 mm to 120 mm	4.8 mm to 153 mm
Optical Zoom	25×	25×	32×	25×	32×
Angle of View	Horizontal field of view: 57.6° to 2.5° (wide-tele) Vertical field of view: 34.4° to 1.4° (wide-tele) Diagonal field of view: 64.5° to 2.9° (wide-tele)	Horizontal field of view: 57.6° to 2.5° (wide-tele) Vertical field of view: 34.4° to 1.4° (wide-tele) Diagonal field of view: 64.5° to 2.9° (wide-tele)	Horizontal field of view: 55.6° to 2.04° (Wide-Tele)	Horizontal field of view: 57.6° to 2.5° (wide-tele) Vertical field of view: 34.4° to 1.4° (wide-tele) Diagonal field of view: 64.5° to 2.9° (wide-tele)	Horizontal field of view: 55.6° to 2.04° (wide-tele) Vertical field of view: 32.4° to 1.14° (wide-tele) Diagonal field of view: 63° to 2.34° (wide-tele)
Aperture Range	F1.6 to F3.8	F1.6 to F3.8	F1.6 to F4.4	F1.6 to F3.8	F1.6 to F4.6
Range	Pan:360°,Tilt:From -15° to 90°	Pan:360°,Tilt:From -15° to 90°	Pan:360° endless; Tilt: From -5° to 90°	Pan:360°,Tilt:From -15° to 90°	Pan:360°,Tilt:From -15° to 90°
Speed	Pan:Configurable, from 0.1°/s to 120°/s, Preset Speed: 120°/s Tilt: Configurable, from 0.1°/s to 80°/s, Preset Speed: 80°/s	Pan:Configurable, from 0.1°/s to 250°/s, Preset Speed: 300°/s Tilt: Configurable, from 0.1°/s to 150°/s, Preset Speed: 200°/s	Pan Manual Speed: Configurable, from 0.1°/s to 250°/s, Preset Speed: 300°/s Tilt Manual Speed: Configurable, from 0.1°/s to 150°/s, Preset Speed: 200°/s	Pan:Configurable, from 0.1°/s to 160°/s, Preset Speed: 240°/s Tilt: Configurable, from 0.1°/s to 120°/s, Preset Speed: 200°/s	Pan:Configurable, from 0.1°/s to 160°/s, Preset Speed: 240°/s Tilt: Configurable, from 0.1°/s to 120°/s, Preset Speed: 200°/s
IR Distance	150m	-	-	150m	150m
Alarm Input	-	2	2	2	2
Alarm Output	-	1	1	1	1
Mini SD Memory Card	Built-in memory card slot, support Micro SD/SDHC/SDXC, up to 256 GB; NAS (NPS, SMB/ CIPS), ANR	Built-in memory card slot, support Micro SD/SDHC/SDXC, up to 256 GB; NAS (NPS, SMB/ CIPS), ANR	-	Built-in memory card slot, support Micro SD/SDHC/SDXC, up to 256 GB; NAS (NPS, SMB/ CIPS), ANR	Built-in memory card slot, support Micro SD/SDHC/SDXC, up to 256 GB; NAS (NPS, SMB/ CIPS), ANR
Power	24 VAC & PoE+ (802.3at, class4), Max.:18 W	24 VAC & PoE+ (802.3at, class4), Max.:18 W	24 VAC and PoE+ (802.3at, class4)Max.: 22W	24 VAC & Hi-PoE, Max.: 40 W (IR Max.19 W)	24 VAC & Hi-PoE, Max.: 40 W (IR Max.19 W)
Dimensions	Φ 208 mm × 305 mm (Φ 8.19" × 12.01")	Φ 220 mm × 280 mm (Φ 8.66" × 11.02")	Φ 220 mm × 305 mm (Φ 8.66" × 12.01") (Outdoor)Φ 183.4 mm × 243 mm (Φ 7.22" × 9.57") (Indoor)Φ 245 mm × 236 mm (Φ 9.65" × 9.29") (In-ceiling)	Φ 220 mm × 353.4 mm (Φ 8.66" × 13.91")	Φ 220 mm × 353.4 mm (Φ 8.66" × 13.91")
Weight (approx.)	Approx. 3.3 kg (7.28 lb)	Approx. 3 kg (6.61 lb)	approx. 3 kg	Approx. 4.5 kg (9.92 lb)	Approx. 4.5 kg (9.92 lb)

www.magazijninrichtingshop.nl - info@magazijninrichtingshop.nl - 020-3363083



HIKVISION PANOVU SERIES
NETWORK CAMERA
HUGE PANORAMAS
INCREDIBLE ZOOM

PanoVu

www.magazijninrichtingshop.nl

2MP



Short Description

PanoVu Mini Series 2MP Network PTZ Camera

Model	DS-2PT3326IZ-DE3
Image Sensor (Panoramic)	Three 1/2.8" progressive scan CMOS
Min. Illumination (Panoramic)	Color: 0.05 Lux @(F2.0, AGC ON) B/W: 0.01 Lux @(F2.0, AGC ON) 0 Lux with IR
Lens (Panoramic)	2 mm/F2.0
Field of View (Panoramic)	Horizontal field of view: 128.5° × 3 Vertical field of view: 75.7° Diagonal field of view: 144°
Video Compression (Panoramic)	H.265/H.264/MJPEG
Image Sensor (PTZ)	1/2.8" progressive scan CMOS
Min. Illumination (PTZ)	Color: 0.05 Lux @(F2.0, AGC ON) B/W: 0.01 Lux @(F2.0, AGC ON) 0 Lux with IR
IR (PTZ)	Up to 10 m IR (radius)
Focal Length (PTZ)	2.8-12 mm, 4×
Horizontal FOV (PTZ)	120° to 56.6° (wide - tele)
Pan and Tilt Range (PTZ)	Pan: 0° to 350°, Tilt: 0° to 90°
Patrol (PTZ)	-
Video Compression (PTZ)	H.265/H.264/MJPEG
Alarm Input/ Output	-
Audio Input/ Output	1/1
Power Supply	12 VDC,PoE+ Max.24 W,PoE+ (Max. 25 W)
	TVS 2000V Lightning Protection, Surge Protection and Voltage Transient Protection

www.magazijninrichtingshop.nl - info@magazijninrichtingshop.nl - tel. +31(0)26-3633683

IP NETWORK VIDEO RECORDERS (NVRs)

Hikvision offers a wide range of NVRs, from the 4-channel to 32-channel, 1 HDD to 4 HDD, 4MP to 12MP in professional series. They offer IP camera monitoring, recording and playback, whatever the requirement.

GENERAL NVR PRODUCT LINE

Professional Series	<ul style="list-style-type: none">- Recording of max 12MP resolution- 32/16/8 channel input- 4/2 SATA interfaces	77/76 NI-I Series
	<ul style="list-style-type: none">- Recording of max 8MP resolution- 32/16/8/4 channel input- 4/2/1 SATA interfaces	77/76 NI-K Series
Economic Series	<ul style="list-style-type: none">- Recording of max 4MP resolution- 8/4 channel input- 1 SATA interfaces	71NI-Q Series

www.magazijninrichtingshop.nl - info@magazijninrichtingshop.nl - tel. +31(0)26-3633683

1U CHASSIS



Short Description	DS-7600NI-K1 Series NVR	DS-7600NI-K1/4P SERIES NVR	DS-7600NI-K2 SERIES NVR	DS-7600NI-K2/P SERIES NVR
Model	DS-7600NI-K1	DS-7600NI-K1/4P	DS-7600NI-K2	DS-7600NI-K2/16P
IP video input	4-ch	4-ch	8-ch	16-ch
Incoming bandwidth	40 Mbps	40 Mbps	80 Mbps	160 Mbps
Outgoing bandwidth	80 Mbps	80 Mbps	160 Mbps	160 Mbps
Recording resolution	8MP/6MP/5MP/4MP/3MP/1080p/UXGA/720p/VGA/4CIF/DCIF/2CIF/CIF/QCIF	8MP/6MP/5MP/4MP/3MP/1080p/UXGA/720p/VGA/4CIF/DCIF/2CIF/CIF/QCIF	8MP/6MP/5MP/4MP/3MP/1080p/UXGA/720p/VGA/4CIF/DCIF/2CIF/CIF/QCIF	8MP/6MP/5MP/4MP/3MP/1080p/UXGA/720p/VGA/4CIF/DCIF/2CIF/CIF/QCIF
HDMI output	4K (3840 × 2160)/30Hz, 1920 × 1080/60Hz, 1600 × 1200/60Hz, 1280 × 1024/60Hz, 1280 × 720/60Hz, 1024 × 768/60Hz	4K (3840 × 2160)/30Hz, 1920 × 1080/60Hz, 1600 × 1200/60Hz, 1280 × 1024/60Hz, 1280 × 720/60Hz, 1024 × 768/60Hz	4K (3840 × 2160)/30Hz, 2K (2560 × 1440)/60Hz, 1920 × 1080/60Hz, 1600 × 1200/60Hz, 1280 × 1024/60Hz, 1280 × 720/60Hz, 1024 × 768/60Hz	4K (3840 × 2160)/30Hz, 2K (2560 × 1440)/60Hz, 1920 × 1080/60Hz, 1600 × 1200/60Hz, 1280 × 1024/60Hz, 1280 × 720/60Hz, 1024 × 768/60Hz
VGA output	1920 × 1080/60Hz, 1600 × 1200/60Hz, 1280 × 1024/60Hz, 1280 × 720/60Hz, 1024 × 768/60Hz	1920 × 1080/60Hz, 1600 × 1200/60Hz, 1280 × 1024/60Hz, 1280 × 720/60Hz, 1024 × 768/60Hz	1920 × 1080/60Hz, 1280 × 1024/60Hz, 1280 × 720/60Hz, 1024 × 768/60Hz	1920 × 1080/60Hz, 1280 × 1024/60Hz, 1280 × 720/60Hz, 1024 × 768/60Hz
Audio output	1-ch, RCA (Linear, 1 KΩ)	1-ch, RCA (Linear, 1 KΩ)	1-ch, RCA (Linear, 1 KΩ)	1-ch, RCA (Linear, 1 KΩ)
Decoding format	H.265/H.264/H.264+	H.265/H.264/H.264+	H.265/H.265+/H.264/H.264+/MPEG4	H.265/H.265+/H.264/H.264+/MPEG4
Capability	2-ch @ 4 MP (30fps)	2-ch @ 4 MP (30fps)	2-ch @ 8 MP (25fps) / 4-ch @ 4MP (30fps) / 8-ch @ 1080p (30fps)	2-ch @ 8 MP (25fps) / 4-ch @ 4MP (30fps) / 8-ch @ 1080p (30fps)
SATA	1 SATA interface for 1 HDD	1 SATA interface for 1 HDD	2 SATA interfaces for 2 HDDs	2 SATA interfaces for 2 HDDs
Capacity	Up to 6TB capacity for each disk	Up to 6TB capacity for each disk	Up to 6TB capacity for each HDD	Up to 6TB capacity for each HDD
Network interface	1 RJ-45 100 Mbps full-duplex Ethernet interface	1 RJ-45 100 Mbps full-duplex Ethernet interface	1, RJ-45 10/100/1000 Mbps self-adaptive Ethernet interface	1 RJ-45 10/100/1000 Mbps self-adaptive Ethernet interface
USB interface	Front panel: 1 × USB 2.0; Rear panel: 1 × USB 2.0	Front panel: 1 × USB 2.0; Rear panel: 1 × USB 2.0	Front panel: 1 × USB 2.0; Rear panel: 1 × USB 3.0	Front panel: 1 × USB 2.0; Rear panel: 1 × USB 3.0
Alarm in/out			4/1	4/1
Power supply	48 VDC	48 VDC	12 VDC	100 to 240 VAC
Consumption(without hard disk or DVD-R/W)	≤ 10 W	≤ 10 W	≤ 15 W	≤ 15 W
Working temperature	-10 to +55°C (14 to 131°F)	-10 to +55°C (14 to 131°F)	-10 to +55°C (14 to 131°F)	-10 to +55°C (14 to 131°F)
Working humidity	10 to 90 %	10 to 90 %	10 to 90 %	10 to 90 %
Dimensions(W × D × H)	315 × 240 × 48 mm (12.4" × 9.4" × 1.9")	315 × 240 × 48 mm (12.4" × 9.4" × 1.9")	385 × 315 × 52 mm (15.2" × 12.4" × 2.0")	385 × 315 × 52 mm (15.2" × 12.4" × 2.0")

www.magazijninrichtingshop.nl - info@magazijninrichtingshop.nl - tel. +31(0)26-3653683

1.5U CHASSIS



Short Description	DS-7600NI-K2/P SERIES NVR	DS-7700NI-K4 SERIES NVR	DS-7700NI-K4/P SERIES NVR
Model	DS-7600NI-K2/8P	DS-7700NI-K4	DS-7700NI-K4/16P
IP video input	8-ch	16-ch	16-ch
Incoming bandwidth	80 Mbps	160 Mbps	160 Mbps
Outgoing bandwidth	160 Mbps	160 Mbps	160 Mbps
Recording resolution	8MP/6MP/5MP/4MP/3MP/1080p/UXGA/720p/VGA/4CIF/DCIF/2CIF/CIF/QCIF	8MP/6MP/5MP/4MP/3MP/1080p/UXGA/720p/VGA/4CIF/DCIF/2CIF/CIF/QCIF	8MP/6MP/5MP/4MP/3MP/1080p/UXGA/720p/VGA/4CIF/DCIF/2CIF/CIF/QCIF
HDMI output	4K (3840 × 2160)/30Hz, 2K (2560 × 1440)/60Hz, 1920 × 1080/60Hz, 1600 × 1200/60Hz, 1280 × 1024/60Hz, 1280 × 720/60Hz, 1024 × 768/60Hz	4K (3840 × 2160)/30Hz, 2K (2560 × 1440)/60Hz, 1920 × 1080/60Hz, 1600 × 1200/60Hz, 1280 × 1024/60Hz, 1280 × 720/60Hz, 1024 × 768/60Hz	4K (3840 × 2160)/30Hz, 2K (2560 × 1440)/60Hz, 1920 × 1080/60Hz, 1600 × 1200/60Hz, 1280 × 1024/60Hz, 1280 × 720/60Hz, 1024 × 768/60Hz
VGA output	1920 × 1080/60Hz, 1280 × 1024/60Hz, 1280 × 720/60Hz, 1024 × 768/60Hz	1920 × 1080/60Hz, 1280 × 1024/60Hz, 1280 × 720/60Hz, 1024 × 768/60Hz	1920 × 1080/60Hz, 1280 × 1024/60Hz, 1280 × 720/60Hz, 1024 × 768/60Hz
Audio output	1-ch, RCA (Linear, 1 KΩ)	1-ch, RCA (Linear, 1 KΩ)	1-ch, RCA (Linear, 1 KΩ)
Decoding format	H.265/H.265+/H.264/H.264+/MPEG4	H.265/H.265+/H.264+/H.264/MPEG4	H.265/H.265+/H.264+/H.264/MPEG4
Capability	2-ch @ 8 MP (25fps) / 4-ch @ 4MP (30fps) / 8-ch @ 1080p (30fps)	2-ch @ 8 MP (25fps) / 4-ch @ 4MP (30fps) / 8-ch @ 1080p (30fps)	2-ch @ 8 MP (25fps) / 4-ch @ 4MP (30fps) / 8-ch @ 1080p (30fps)
SATA	2 SATA interfaces for 2 HDDs	4 SATA interfaces for 4 HDDs	4 SATA interfaces for 4 HDDs
Capacity	Up to 6TB capacity for each HDD	Up to 6TB capacity for each HDD	Up to 6TB capacity for each HDD
Network interface	1 RJ-45 10/100/1000 Mbps self-adaptive Ethernet interface	2 RJ-45 10/100/1000 Mbps self-adaptive Ethernet interfaces	2 RJ-45 10/100/1000 Mbps self-adaptive Ethernet interfaces
USB interface	Front panel: 1 × USB 2.0; Rear panel: 1 × USB 3.0	Front panel: 2 × USB 2.0; Rear panel: 1 × USB 3.0	Front panel: 2 × USB 2.0; Rear panel: 1 × USB 3.0
Alarm in/out	4/1	16/4	16/4
Power supply	100 to 240 VAC	100 to 240 VAC	100 to 240 VAC
Consumption(without hard disk or DVD-R/W)	≤ 15 W	≤ 20 W	≤ 20 W
Working temperature	-10 to +55° C (14 to 131° F)	-10 to +55° C (14 to 131° F)	-10 to +55° C (14 to 131° F)
Working humidity	10 to 90 %	10 to 90 %	10 to 90 %
Dimensions(W × D × H)	385 × 315 × 52 mm (15.2" × 12.4" × 2.0")	445 × 400 × 71 mm (17.5" × 15.7" × 2.8")	445 × 400 × 71 mm (17.5" × 15.7" × 2.8")

www.magazijninrichtingshop.nl - info@magazijninrichtingshop.nl - tel. +31(0)26-3633683

1U CHASSIS



1.5U CHASSIS



Short Description	DS-7600NI-I2 SERIES NVR	DS-7600NI-I2/P SERIES NVR	DS-7600NI-I2/P SERIES NVR	DS-7700NI-I4 SERIES NVR
Model	DS-7600NI-I2	DS-7600NI-I2/16P	DS-7600NI-I2/8P	DS-7700NI-I4
IP video input	8-ch	16-ch	8-ch	8-ch
Incoming bandwidth	80 Mbps	160 Mbps	80 Mbps	80 Mbps
Outgoing bandwidth	256 Mbps	256 Mbps	256 Mbps	256 Mbps
Recording resolution	12MP/8MP/6MP / 5MP/4MP/3MP / 1080P/UXGA/720P/VGA/4CIF/DCIF/2CIF/CIF/QCIF	12MP/8MP/6 MP/5 MP/4MP/3MP/1080p/UXGA/720p /VGA/4CIF /DCIF/2CIF/CIF/QCIF	12MP/8MP/6MP/5 MP/4MP/3MP/1080p/UXGA/720p/VGA/4CIF /DCIF/2CIF/CIF/QCIF	12MP/8MP/6 MP/5 MP/4MP/3MP/1080p/UXGA/720p/VGA/4CIF/DCIF/2CIF/CIF/QCIF
HDMI output	4K (3840 × 2160)/60Hz, 4K (3840 × 2160)/30Hz, 1920 × 1080p/60Hz, 1600 × 1200/60Hz, 1280 × 1024/60Hz, 1280 × 720/60Hz, 1024 × 768/60Hz	4K (3840 × 2160)/60Hz, 4K (3840 × 2160)/30Hz, 2K (2560 × 1440)/60Hz, 1920 × 1080p/60Hz, 1600 × 1200/60Hz, 1280 × 1024/60Hz, 1280 × 720/60Hz, 1024 × 768/60Hz	4K (3840 × 2160)/60Hz, 4K (3840 × 2160)/30Hz, 2K (2560 × 1440)/60Hz, 1920 × 1080p/60Hz, 1600 × 1200/60Hz, 1280 × 1024/60Hz, 1280 × 720/60Hz, 1024 × 768/60Hz	4K (3840 × 2160)/60Hz, 4K (3840 × 2160)/30Hz, 1920 × 1080p/60Hz, 1600 × 1200/60Hz, 1280 × 1024/60Hz, 1280 × 720/60Hz, 1024 × 768/60Hz
VGA output	1920 × 1080p/60Hz, 1280 × 1024/60Hz, 1280 × 720/60Hz, 1024 × 768/60Hz	1920 × 1080p/60Hz, 1280 × 1024/60Hz, 1280 × 720/60Hz, 1024 × 768/60Hz	1920 × 1080p/60Hz, 1280 × 1024/60Hz, 1280 × 720/60Hz, 1024 × 768/60Hz	1920 × 1080p/60Hz, 1280 × 1024/60Hz, 1280 × 720/60Hz, 1024 × 768/60Hz
Audio output	1-ch, RCA (Linear, 1 K Ω)	1-ch, RCA (Linear, 1 K Ω)	1-ch, RCA (Linear, 1 K Ω)	1-ch, RCA (Linear, 1 K Ω)
Decoding format	H.265/ H.265+/H.264/H.264+/MPEG4	H.265/H.265+/H.264/H.264+/MPEG4	H.265/H.265+/H.264/H.264+/MPEG4	H.265/H.265+/H.264/H.264+/MPEG4
Capability	2-ch @ 4K, or 8-ch @ 1080p	4-ch @ 4K, or 16-ch @ 1080p	2-ch @ 8 MP, or 8-ch @ 1080p	2-ch @ 4K, or 8-ch @ 1080p
SATA	2 SATA interfaces for 2 HDDs	2 SATA interfaces for 2 HDDs	2 SATA interfaces for 2 HDDs	4 SATA interfaces for 4 HDDs
Capacity	Up to 6TB capacity for each HDD	Up to 6TB capacity for each HDD	Up to 6TB capacity for each HDD	Up to 6TB capacity for each HDD
Network interface	1 RJ-45 10/100/1000 Mbps self-adaptive Ethernet interface	1 RJ-45 10/100/1000 Mbps self-adaptive Ethernet interface	1 RJ-45 10/100/1000 Mbps self-adaptive Ethernet interface	2 RJ-45 10/100/1000 Mbps self-adaptive Ethernet interfaces
USB interface	Front panel: 1 × USB 2.0; Rear panel: 1 × USB 3.0	Front panel: 1 × USB 2.0; Rear panel: 1 × USB 3.0	Front panel: 1 × USB 2.0; Rear panel: 1 × USB 3.0	Front panel: 2 × USB 2.0; Rear panel: 1 × USB 3.0
Alarm in/out	4/1	4/1	4/1	16/4
Power supply	12 VDC	100 to 240 VAC, 50 to 60 Hz	100 to 240 VAC, 50 to 60 Hz	100 to 240 VAC
Consumption(without hard disk or DVD-R/W)	≤ 15 W	≤ 15 W	≤ 15 W	≤ 20 W
Working temperature	-10 to +55° C (+14 to +131° F)	-10 to +55° C (+14 to +131° F)	-10 to +55° C (+14 to +131° F)	-10 to +55° C (+14 to +131° F)
Working humidity	10 to 90 %	10 to 90 %	10 to 90 %	10 to 90 %
Dimensions(W × D × H)	385 × 315 × 52 mm (15.2" × 12.4" × 2.0")	385 × 315 × 52 mm (15.2" × 12.4" × 2.0")	385 × 315 × 52 mm (15.2" × 12.4" × 2.0")	445 × 400 × 71 mm (17.5" × 15.7" × 2.8")

www.magazijninrichtingshop.nl | info@magazijninrichtingshop.nl | tel. +31(0)26-3657683



Short Description	DS-7700NI-I4/P SERIES NVR	DS-7700NI-I4/P SERIES NVR
Model	DS-7700NI-I4/16P	DS-7700NI-I4/8P
IP video input	16-ch	8-ch
Incoming bandwidth	160 Mbps	80 Mbps
Outgoing bandwidth	256 Mbps	256 Mbps
Recording resolution	12MP/8 MP/6MP/5 MP/4MP/3MP/1080p/UXGA/720p/VGA/4CIF/DCIF/2CIF/CIF/QCIF	12MP/8 MP/6MP/5 MP/4MP/3MP/1080p/UXGA/720p/VGA/4CIF/DCIF/2CIF/CIF/QCIF
HDMI output	4K (3840 × 2160)/60Hz, 4K (3840 × 2160)/30Hz, 1920 × 1080p/60Hz, 1600 × 1200/60Hz, 1280 × 1024/60Hz, 1280 × 720/60Hz, 1024 × 768/60Hz	4K (3840 × 2160)/60Hz, 4K (3840 × 2160)/30Hz, 1920 × 1080p/60Hz, 1600 × 1200/60Hz, 1280 × 1024/60Hz, 1280 × 720/60Hz, 1024 × 768/60Hz
VGA output	1920 × 1080p/60Hz, 1280 × 1024/60Hz, 1280 × 720/60Hz, 1024 × 768/60Hz	1920 × 1080p/60Hz, 1280 × 1024/60Hz, 1280 × 720/60Hz, 1024 × 768/60Hz
Audio output	1-ch, RCA (Linear, 1 KΩ)	1-ch, RCA (Linear, 1 KΩ)
Decoding format	H.265/H.265+/H.264/H.264+/MPEG4	H.265/H.265+/H.264/H.264+/MPEG4
Capability	4-ch @ 4K, or 16-ch @ 1080p	2-ch @ 4K, or 8-ch @ 1080p
SATA	4 SATA interfaces for 4 HDDs	4 SATA interfaces for 4 HDDs
Capacity	Up to 6TB capacity for each HDD	Up to 6TB capacity for each HDD
Network interface	1 RJ-45 10/100/1000 Mbps self-adaptive Ethernet interface	1 RJ-45 10/100/1000 Mbps self-adaptive Ethernet interface
USB interface	Front panel: 2 × USB 2.0; Rear panel: 1 × USB 3.0	Front panel: 2 × USB 2.0; Rear panel: 1 × USB 3.0
Alarm in/out	16/4	16/4
Power supply	100 to 240 VAC	100 to 240 VAC
Consumption(without hard disk or DVD-R/W)	≤20 W	≤20 W
Working temperature	-10 to +55° C (+14 to +131° F)	-10 to +55° C (+14 to +131° F)
Working humidity	10 to 90 %	10 to 90 %
Dimensions(W × D × H)	445 × 400 × 71 mm (17.5" × 15.7" × 2.8")	445 × 400 × 71 mm (17.5" × 15.7" × 2.8")

www.magazijninrichtingshop.nl - info@magazijninrichtingshop.nl - tel. +31(0)26-3633683



4K ULTRA HIGH DEFINITION
SHOWING CRYSTAL CLEAR DETAILS

www.magazijninrichtingshop.nl - tel. +31 (0) 26 3633683
info@magazijninrichtingshop.nl

TURBO HD
4.0



TURBO HD 4.0 SOLUTION 4K AND H.265+ A NEW REVOLUTION FOR THE ANALOGUE WORLD

Hikvision introduced its first Turbo HD Solution in 2012, and revolutionised analogue security. After years of fine-tuning and perfecting this powerful solution, Hikvision has launched Turbo HD 4.0 – a brand new revolution in high-definition, high-performance surveillance video.

Turbo HD 4.0 technology gives your analogue security system the powerful boost yet, upgrading the total system to amazing ultra-HD 4K resolution. Bandwidth efficiency improves by 75% using H.265+ compression. And by transmitting both HD video and power over the same coax cable, PoC technology ensures installations are faster, simpler, and less expensive.

www.magazijninrichtingshop.nl - info@magazijninrichtingshop.nl - tel. +31(0)26-3633683

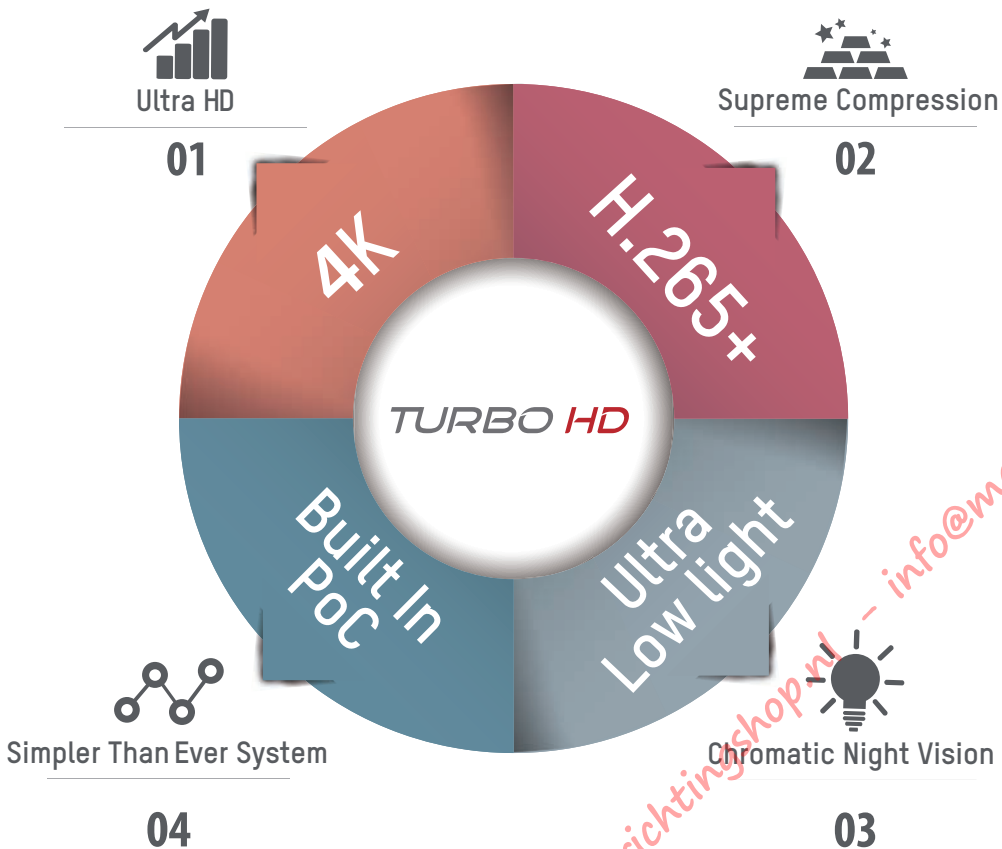

01 4K ULTRA HD

Sharp, precise, clear video can make all the difference in critical surveillance situations, enabling security staff to quickly identify suspicious individuals, objects, and movement, and take the right action at the right time.

02 H.265+ SUPREME COMPRESSION

More than three years of research and accumulation empowered Hikvision to be the first to release H.265+ on an analogue system—a revolution for analogue. H.265+ takes a huge step up in efficiency over H.264—reducing bitrates by 75% on average while maintaining high transmission quality.

03 ULTRA-LOW LIGHT CHROMATIC NIGHT VISION

Ultra-low illumination cameras from Hikvision vastly improve the efficiency of night monitoring. High-definition 1080p displays come to life with the amazing ultra-low illumination surveillance cameras. With 120 dB WDR and built-in PoC function, these cameras offer users the most advanced security features available. Rest assured that you will see what's really there - in the shadows, at night, and under conditions that leave other cameras in the dark.

04 BUILT IN PoC SIMPLER THAN EVER SYSTEM

With Hikvision's Turbo HD 4.0 Solution, installers don't have to pull wire. Power-over-coax (POC) supplies the technology to use coaxial cable to integrate video and DC power. This innovation consists of a front-end POC camera and a back-end Turbo HD DVR, directly embedding the POC power supply into the back-end DVR device. It then transmits the video signal through the coaxial cable and solves the power supply problem for front-end equipment. Turbo HD 4.0 Solutions reduce the wiring area, save space and reduce the costs of labour.

www.magazijninrichtingshop.nl - info@magazijninrichtingshop.nl - tel. +31(0)2613633683

TURBO HD CAMERAS

Our Turbo HD products are based on HDTV technology, an open standard enabling different products and technologies to be integrated into a single system. The products also offer many of the cutting-edge technologies on IP cameras - like Ultra-low light technology and vandal-proof capabilities.

The products are split into two series to maximise application flexibility: the Professional Series, with resolutions of up to 8MP, come in multiple form factors to suit every need; while the Economic Series brings a range of cameras for lower budget solutions.

CHOOSING YOUR CAMERA

8MP	U8T	Ultra-low light
5MP	H5T	Ultra-low light
	H0T	
1080P	D9T, D8T	Ultra-low light
	D0T	
720P	C0T	

www.magazijninrichtingshop.nl - info@magazijninrichtingshop.nl - tel. +31(0)26-3633683

FIXED BULLET CAMERA

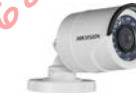

Short Description	HD720p IR Bullet Camera	HD720p IR Bullet Camera	HD720p IR Bullet Camera	HD720p IR Bullet Camera	2 MP PoC IR Bullet Camera
Model	DS-2CE16C0T-IRF	DS-2CE16C0T-IRPF	DS-2CE16C0T-IT3F	DS-2CE16C0T-IT5F	DS-2CE16D0T-IRE
Image Sensor	1 MP CMOS Image sensor	1 MP CMOS Image sensor	1 MP CMOS Image sensor	1 MP CMOS Image sensor	2MP CMOS Image Sensor
Effective Pixels	1296(H)*732(V)	1296(H)*732(V)	1296(H)*732(V)	1296(H)*732(V)	1920(H)*1080(V)
Min. illumination	0.1 Lux@(F1.2,AGC ON),0 Lux with IR	0.1 Lux@(F1.2,AGC ON),0 Lux with IR	0.1 Lux@(F1.2,AGC ON),0 Lux with IR	0.1 Lux@(F1.2,AGC ON),0 Lux with IR	0.01 Lux @ (F1.2,AGC ON),0 Lux with IR
Lens	2.8 mm	2.8 mm	2.8 mm	3.6 mm	3.6mm
Day & Night	ICR	ICR	ICR	ICR	ICR
Angle Adjustment	Pan: 0-360°, Tilt: 0-180°, Rotation: 0-360°	Pan: 0-360°, Tilt: 0-180°, Rotation: 0-360°	Pan: 0-360°, Tilt: 0-180°, Rotation: 0-360°	Pan: 0-360°, Tilt: 0-180°, Rotation: 0-360°	Pan: 0 - 360°, Tilt: 0 - 180°, Rotation: 0 - 360°
WDR					
Video Frame Rate	720p@25fps	720p@25fps	720p@25fps	720p@25fps	1080p@25fps
HD Video Output	1 Analog HD output	1 Analog HD output	1 Analog HD output	1 Analog HD output	1 Analog HD output
CVBS Output					
Operating Conditions	-40 °C – 60 °C (-40 °F – 140 °F), Humidity 90% or less (non-condensing)	-40 °C – 60 °C (-40 °F – 140 °F), Humidity 90% or less (non-condensing)	-40 °C – 60 °C (-40 °F – 140 °F), Humidity 90% or less (non-condensing)	-40 °C – 60 °C (-40 °F – 140 °F), Humidity 90% or less (non-condensing)	-40 °C to 60 °C (-40 °F to 140 °F), humidity: 90% or less (non-condensation)
Power Supply	12 VDC±15%	12 VDC±15%	12 VDC±15%	12 VDC±15%	12 VDC±15%/PoC
Power Consumption	Max. 4W	Max. 4W	Max. 4W	Max. 5 W	Max. 4W
Protection Level	IP66	IP66	IP66	IP66	IP66
IR Range	Up to 20m	Up to 40m	Up to 40m	Up to 80 m	Up to 20m
Dimensions	Φ 70 mm × 154.5 mm (2.76" × 6.08")	Φ 70 mm × 154.5 mm (2.76" × 6.08")	86.7 mm × 81.6 mm × 226 mm (3.4" × 3.2" × 8.9")	86.7 mm × 81.6 mm × 226 mm (3.4" × 3.2" × 8.9")	Φ 70×149.5mm (Φ 2.76"×5.89")
Weight	400 g (0.88 lb.)	300 g (0.66 lb.)	700 g (1.54 lb.)	700 g (1.54 lb.)	400g

www.magazijninrichtingshop.nl - info@magazijninrichtingshop.nl - tel: +31(0)26-3633683



NEW



NEW



NEW



NEW

Short Description	HD1080P IR Bullet Camera	2 MP PoC EXIR Bullet Camera	HD1080P EXIR Bullet Camera	5 MP Bullet Camera	5 MP Bullet Camera
Model	DS-2CE16D0T-IRF	DS-2CE16D0T-IT1/3/5E	DS-2CE16D0T-IT3/5F	DS-2CE16H0T-IT3F	DS-2CE16H0T-ITF
Image Sensor	2MP CMOS Image Sensor	2MP CMOS Image Sensor	2MP CMOS Image Sensor	5 MP CMOS image sensor	5 MP CMOS image sensor
Effective Pixels	1920(H)*1080(V)	1920(H)*1080(V)	1920(H)*1080(V)	2560 (H) × 1944 (V)	2560 (H) × 1944 (V)
Min. illumination	0.01 Lux @ (F1.2,AGC ON),0 Lux with IR	0.01 Lux @ (F1.2,AGC ON),0 Lux with IR	0.01 Lux @ (F1.2,AGC ON),0 Lux with IR	0.01 Lux @ (F1.2, AGC ON), 0 Lux with IR	0.01 Lux @ (F1.2, AGC ON), 0 Lux with IR
Lens	2.8mm	2.8 mm, 3.6 mm	3.6mm	2.8 mm	2.8 mm
Day & Night	ICR	ICR	ICR	ICR	ICR
Angle Adjustment	Pan: 0 - 360°, Tilt: 0 - 180°, Rotation: 0 - 360°	Pan: 0 - 360°, Tilt: 0 - 180°, Rotation: 0 - 360°	Pan: 0 - 360°, Tilt: 0 - 180°, Rotation: 0 - 360°	Pan: 0-360°; Tilt: 0-180°; Rotate: 0-360°	Pan: 0-360°; Tilt: 0-180°; Rotate: 0-360°
WDR				Digital WDR	Digital WDR
Video Frame Rate	1080p@25fps	1080p@25fps	1080p@25fps	5 MP@20fps, 4 MP@25fps, 1080p@25fps	5 MP@20fps, 4 MP@25fps, 1080p@25fps
HD Video Output	1 Analog HD output	1 Analog HD output	1 Analog HD output	1 Analog HD output	1 Analog HD output
CVBS Output		1 Vp-p composite output (75Ω/BNC)			
Operating Conditions	-40 °C – 60 °C (-40 °F – 140 °F), Humidity 90% or less (non-condensing)	-40 °C to 60 °C (-40 °F to 140 °F), humidity: 90% or less (non-condensation)	-40 °C – 60 °C (-40 °F – 140 °F), Humidity 90% or less (non-condensing)	-40 °C – 60 °C (-40 °F – 140 °F), Humidity 90% or less (non-condensing)	-40 °C – 60 °C (-40 °F – 140 °F), Humidity 90% or less (non-condensing)
Power Supply	12 VDC±15%	12 VDC±30%/PoC.af	12 VDC±15%	12 V DC ±25%	12 V DC ±25%
Power Consumption	Max. 4W	Max. 4W	Max. 6W	Max. 4.3 W	Max. 4.3 W
Protection Level	IP66	IP66	IP66	IP67	IP67
IR Range	Up to 20m	Up to 20m	Up to 80m	Up to 40 m	Up to 20 m
Dimensions	Φ70×149.5mm (Φ2.76"×5.89")	86.7 mm × 81.6 mm × 226 mm(3.4" × 3.2" × 8.9")	86.22×82.05×220.13mm(3.39"×3.23"×8.67")	86.7 mm × 81.6 mm × 226 mm (3.41" × 3.23" × 8.67")	58 mm × 61 mm × 163 mm (2.28" × 2.40" × 6.42")
Weight	400g	Approx. 430 g (0.95 lb)	430 g (0.95 lbs)	Approx. 680 g (1.5 lb.)	Approx. 350 g (0.77 lb.)

www.magazijninrichtingshop.nl - info@magazijninrichtingshop.nl - tel. 026-3633683

VARI-FOCAL BULLET CAMERA



FIXED TURRET CAMERA

Short Description	HD720p IR Bullet Camera	2 MP Vari-focal PoC Bullet Camera	2 MP IR Bullet Camera	5 MP Bullet Camera	HD 720p IR Turret Camera
Model	DS-2CE16C0T-VFIR3F	DS-2CE16D0T-VFIR3E	DS-2CE16D0T-VFIR3F	DS-2CE16H0T-(A)IT3ZF	DS-2CE56C0T-IRMF
Image Sensor	1 MP CMOS image sensor	2MP CMOS Image Sensor	2MP CMOS Image Sensor	5 MP CMOS image sensor	1 MP CMOS Image sensor
Effective Pixels	1296(H)*732(V)	1920(H)*1080(V)	1920(H)*1080(V)	2560 (H) × 1944 (V)	1296(H)*732(V)
Min. illumination	0.1 Lux @ (F1.2,AGC ON),0 Lux with IR	0.01 Lux @ (F1.2,AGC ON),0 Lux with IR	0.01 Lux@(F1.2,AGC ON),0 Lux with IR	0.01 Lux @ (F1.2, AGC ON), 0 Lux with IR	0.1 Lux@(F1.2,AGC ON),0 Lux with IR
Lens	2.8 - 12 mm	2.8 mm-12 mm	2.8 mm-12 mm	2.7-13.5mm	2.8 mm
Day & Night	ICR	ICR	ICR	ICR	ICR
Angle Adjustment	Pan: 0-360°, Tilt: 0-90°, Rotation: 0-360°	Pan: 0-360°, Tilt: 0-90°, Rotation: 0-360°	Pan: 0-360°, Tilt: 0-90°, Rotation: 0-360°	Pan: 0-360°; Tilt: 0-90°; Rotate: 0-360°	Pan: 0-360°, Tilt: 0-75°, Rotation: 0-360°
WDR				Digital WDR	
Video Frame Rate	720p@25fps	1080p@25fps	1080p@25fps	5 MP@20fps, 4 MP@25fps, 1080p@25fps	720p@25fps
HD Video Output	1 Analog HD output	1 Analog HD output	1 Analog HD output	1 Analog HD output	1 Analog HD output
CVBS Output					
Operating Conditions	-40 °C – 60 °C (-40 °F – 140 °F), Humidity 90% or less (non-condensing)	-40 °C to 60 °C (-40 °F to 140 °F), humidity: 90% or less (non-condensation)	-40 °C to 60 °C (-40 °F to 140 °F), humidity: 90% or less (non-condensation)	-40 °C – 60 °C (-40 °F – 140 °F), Humidity 90% or less (non-condensing)	-40 °C – 60 °C (-40 °F – 140 °F), Humidity 90% or less (non-condensing)
Power Supply	12 VDC±15%	12 VDC ±15%/PoC.at	12 V DC±15%	12 VDC ±15%, 24 VAC ±15%	12 VDC±15%
Power Consumption	Max. 4W	Max.6.5 W	Max.4 W	Max. 8.9 W	Max. 4 W
Protection Level	IP66	IP66	IP66	IP67	IP66
IR Range	Up to 40m	Up to 40m	Up to 40 m	Up to 40 m	Up to 20 m
Dimensions	92mm×84.8mm×269.6mm (3.62"×3.34"×3.34")	92 mm × 89 mm × 269.6 mm (3.62" × 3.5" × 10.6")	92mm×84.8mm×269.6mm (3.62"×3.34"×3.34")	84.5 mm × 92 mm × 255.1 mm (3.33" × 3.62" × 10")	89.47 × 67.6 mm (3.52" × 2.7")
Weight	Approx. 900g (1.98lb)	Approx. 900 g (1.98 lb.)	Approx. 900g (1.98lb)		340 g (0.75 lb.)

www.magazijninrichtingshop.nl - info@magazijninrichtingshop.nl - tel: 020-26-363083



Short Description	HD 720p Indoor IR Turret Camera	HD 720p EXIR Turret Camera	HD1080p IR Turret Camera	2 MP IR Turret Camera	2 MP Indoor IR Dome Camera
Model	DS-2CE56C0T-IRPF	DS-2CE56C0T-IT3F	DS-2CE56D0T-IRF	DS-2CE56D0T-IRMF	DS-2CE56D0T-IRMMF
Image Sensor	1 MP CMOS Image sensor	1 MP CMOS Image sensor	2MP CMOS Image sensor	2MP CMOS Image Sensor	2MP CMOS Image Sensor
Effective Pixels	1296(H)*732(V)	1296(H)*732(V)	1920(H)*1080(V)	1920(H)*1080(V)	1920(H)*1080(V)
Min. illumination	0.1 Lux@(F1.2,AGC ON),0 Lux with IR	0.1 Lux@(F1.2,AGC ON),0 Lux with IR	0.01 Lux@(F1.2,AGC ON),0 Lux with IR	0.01 Lux@(F1.2,AGC ON),0 Lux with IR	0.01 Lux@(F1.2,AGC ON),0 Lux with IR
Lens	2.8 mm	2.8 mm	3.6 mm	2.8mm	2.8 mm
Day & Night	ICR	ICR	ICR	ICR	ICR
Angle Adjustment	Pan: 0-360°, Tilt: 0-75°, Rotation: 0-360°	Pan: 0-360°, Tilt: 0-75°, Rotation: 0-360°	Pan: 0 - 360°, Tilt: 0 - 75°, Rotation: 0 - 360°	Pan: 0 - 360°, Tilt: 0 - 75°, Rotation: 0 - 360°	Pan: 0-350°, Tilt: 0-70°, Rotation: 0-350°
WDR					
Video Frame Rate	720p@25fps	720p@25fps	1080p@25fps	1080p@25fps	1080p@25fps
HD Video Output	1 Analog HD output	1 Analog HD output	1 Analog HD output	1 Analog HD output	1 Analog HD output
CVBS Output					
Operating Conditions	-40 °C – 60 °C (-40 °F – 140 °F), Humidity 90% or less (non-condensing)	-40 °C – 60 °C (-40 °F – 140 °F), Humidity 90% or less (non-condensing)	-40 °C to 60 °C (-40 °F to 140 °F), Humidity: 90% or less (non-condensation)	-40 °C to 60 °C (-40 °F to 140 °F), Humidity: 90% or less (non-condensation)	-40 °C to 60 °C (-40 °F to 140 °F), Humidity: 90% or less (non-condensation)
Power Supply	12 VDC±15%	12 VDC±15%	12 V DC±15%	12 VDC±15%	12 VDC±15%
Power Consumption	Max. 4 W	Max. 4 W	Max. 4 W	Max. 4W	Max. 4W
Protection Level		IP66	IP66	IP66	
IR Range	Up to 20 m	Up to 40 m	Up to 20 m	Up to 20m	Up to 20m
Dimensions	Φ 89.9 mm × 70.1 mm (3.54" × 2.76")	Φ 110 mm × 93.2 mm (4.33" × 3.67")	Φ 89.9 × 70.1 mm (3.54" × 2.76")	89.47 × 67.6 mm (3.52" × 2.7")	Φ 98 × 65.4 mm (φ 3.86" × 2.57")
Weight	250 g (0.55 lb.)	350 g (0.77 lb.)	280 g (0.62 lb.)	340 g (0.75 lb.)	240 g (0.53 lb.)

www.magazijninrichtingshop.nl - info@magazijninrichtingshop.nl - tel: 020-26-3633683

FIXED TURRET CAMERA



VARI-FOCAL TURRET CAMERA



Short Description	2 MP Indoor IR Turret Camera	2 MP PoC EXIR Turret Camera	HD 1080p EXIR Turret Camera	2 MP Vari-focal PoC Turret Camera	2 MP IR Turret Camera
Model	DS-2CE56D0T-IRPF	DS-2CE56D0T-IT3E	DS-2CE56D0T-IT3F	DS-2CE56D0T-VFIR3E	DS-2CE56D0T-VFIR3F
Image Sensor	2MP CMOS Image Sensor	2MP CMOS Image Sensor	2MP CMOS Image Sensor	2MP CMOS Image Sensor	2MP CMOS Image Sensor
Effective Pixels	1920(H)*1080(V)	1920(H)*1080(V)	1920(H)*1080(V)	1920(H)*1080(V)	1920(H)*1080(V)
Min. illumination	0.01 Lux @ (F1.2,AGC ON),0 Lux with IR	0.01 Lux @ (F1.2,AGC ON),0 Lux with IR	0.01 Lux @ (F1.2,AGC ON),0 Lux with IR	0.01 Lux @ (F1.2,AGC ON),0 Lux with IR	0.01 Lux @ (F1.2,AGC ON),0 Lux with IR
Lens	2.8 mm	2.8 mm, 3.6 mm	3.6 mm	2,8 mm-12 mm	2.8 mm-12 mm
Day & Night	ICR	ICR	ICR	ICR	ICR
Angle Adjustment	Pan: 0-360°, Tilt: 0-75°, Rotation: 0-360°	Pan: 0-360°, Tilt:0-75°, Rotate: 0-360°	Pan: 0 - 360°, Tilt: 0 - 75°, Rotation: 0 - 360°	Pan: 0-360°, Tilt: 0-75°, Rotation: 0-360°	Pan: 0-360°, Tilt: 0-75°, Rotation: 0-360°
WDR					
Video Frame Rate	1080p@25fps	1080p@25fps	1080p@25fps	1080p@25fps	1080p@25fps
HD Video Output	1 Analog HD output	1 Analog HD output	1 Analog HD output	1 Analog HD output	1 Analog HD output
CVBS Output		1 Vp-p composite output (75Ω/BNC)			
Operating Conditions	-40 °C to 60 °C [-40 °F to 140 °F], Humidity: 90% or less (non-condensation)	-40 °C to 60 °C [-40 °F to 140 °F], humidity: 90% or less (non-condensation)	-40 °C - 60 °C [-40 °F - 140 °F], Humidity: 90% or less (non-condensing)	-40 °C to 60 °C [-40 °F to 140 °F], humidity: 90% or less (non-condensation)	-40 °C to 60 °C [-40 °F to 140 °F], Humidity: 90% or less (non-condensation)
Power Supply	12 V DC±15%	12 VDC±30%/PoC.af	12 VDC±15%	12 VDC ±15%/PoC.at	12 VDC±15%
Power Consumption	Max. 4 W	Max. 4 W	Max. 4W	Max. 6.5 W	Max. 4W
Protection Level		IP66	IP66	IP66	IP66
IR Range	Up to 20 m	Up to 40m	Up to 40m	Up to 40m	Up to 40m
Dimensions	Φ 89.9 mm × 70.1 mm (3.54" × 2.76")	Φ 110 mm × 93.2 mm (4.33" × 3.67")	Φ 110 mm × 93.2 mm (4.33" × 3.67")	Ø 130.5 mm × 102.4 mm (5.14" × 4.03")	Φ 130.54 × 102.4mm (Φ 5.1" × 4")
Weight	250 g (0.55 lb.)	Approx. 350 g (0.77 lb.)	350 g (0.77 lb.)	Approx. 710 g (1.57 lb.)	Approx. 710g

www.magazijninrichtingshop.nl - info@magazijninrichtingshop.nl - tel: 020-3633083

VARI-FOCAL DOME CAMERA



FIXED TURRET CAMERA



FIXED TURRET CAMERA



Short Description

2 MP Vandal Proof PoC Dome Camera

HD 1080p Vandal Proof IR Dome Camera

5 MP Turret Camera

5 MP Turret Camera

5 MP Turret Camera

Model	DS-2CE56D0T-VPIR3E	DS-2CE56D0T-VPIR3F	DS-2CE56H0T-IT3F	DS-2CE56H0T-IT3E	DS-2CE56H0T-ITMF
Image Sensor	2MP CMOS Image Sensor	2MP CMOS image sensor	5 MP CMOS image sensor	5 MP CMOS image sensor	5 MP CMOS image sensor
Effective Pixels	1920(H)*1080(V)	1920 (H) × 1080 (V)	2560 (H) × 1944 (V)	2560 (H) × 1944 (V)	2560 (H) × 1944 (V)
Min. illumination	0.01 Lux @ (F1.2,AGC ON), 0 Lux with IR	0.01 Lux@(F1.2,AGC ON), 0 Lux with IR	0.01 Lux @ (F1.2, AGC ON), 0 Lux with IR	Color 0.01 Lux @ (F1.2, AGC ON), 0 Lux with IR	0.01 Lux @ (F1.2, AGC ON), 0 Lux with IR
Lens	2.8 mm-12 mm	2.8 - 12 mm	2.8 mm	2.7- 13.5 mm	2.8 mm
Day & Night	ICR	ICR	ICR	ICR	ICR
Angle Adjustment	Pan: 0-355°, Tilt: 0-75°, Rotation: 0-355°	Pan: 0-355°, Tilt: 0-75°, Rotation: 0-355°	Pan: 0-360°; Tilt: 0-75°; Rotate: 0-360°	Pan: 0-360°; Tilt: 0-75°; Rotate: 0-360°	Pan: 0-360°; Tilt: 0-75°; Rotate: 0-360°
WDR			Digital WDR		Digital WDR
Video Frame Rate	1080p@25fps	1080p@25fps	5 MP@20fps, 4 MP@25fps, 1080p@25fps	5 MP@20fps, 4 MP@25fps, 1080p@25fps	5 MP@20fps, 4 MP@25fps, 1080p@25fps
HD Video Output	1 Analog HD output	1 Analog HD output	1 Analog HD output	1 Analog HD output	1 Analog HD output
CVBS Output					
Operating Conditions	-40 °C to 60 °C (-40 °F to 140 °F), humidity: 90% or less (non-condensation)	-40 °C to 60 °C (-40 °F to 140 °F), Humidity 90% or less (non-condensation)	-40 °C - 60 °C (-40 °F - 140 °F), Humidity 90% or less (non-condensing)	-40 °C to 60 °C (-40 °F to 140 °F), humidity: 90% or less (non-condensation)	-40 °C - 60 °C (-40 °F - 140 °F), Humidity 90% or less (non-condensing)
Power Supply	12 VDC ±15%/PoC.af	12 VDC±15%	12 V DC ±25%	12 VDC ±25%	12 V DC ±25%
Power Consumption	Max. 4 W	Max. 4 W	Max. 4.3 W	Max. 6.3 W	Max. 4.3 W
Protection Level	IP66		IP67	IP67	IP67
IR Range	Up to 40m	Up to 40 m	Up to 40 m	Up to 40 m	Up to 20 m
Dimensions	∅ 145.3 × 124.2 mm (∅ 5.72" × 4.89")	∅ 145.3 × 124.2 mm (∅ 5.72" × 4.89")	∅ 110 mm × 93.2 mm (∅ 4.33" × 3.67")	123.86 mm × 134.3 mm × 110.11 mm (4.88" × 5.29" × 4.38")	91 mm × 82.6 mm × 68.3 mm (3.58" × 3.25" × 2.69")
Weight	1300 g (2.87 lb.)	1300 g	350 g (0.77 lb.)	Approx. 580 g (1.28 lb.)	Approx. 350 g (0.77 lb.)

www.magazijninrichtingshop.nl - info@magazijninrichtingshop.nl - tel: +31(0)26-3633683

	BOX CAMERA	NEW HD1080P WDR Box Camera	VARI-FOCAL BULLET CAMERA	BOX CAMERA	FIXED BULLET CAMERA
Short Description	 2 MP Ultra-Low Light Box Camera	 HD1080P WDR Box Camera	 HD1080P Ultra Low-Light PoC Bullet Camera	 HD1080P WDR POC Box Camera	 HD1080P Ultra Low-Light PoC Bullet Camera
Model	DS-2CC12D8T-AMM	DS-2CC12D9T-(A)	DS-2CC12D9T-AIT3ZE	DS-2CC12D9T-E	DS-2CC12D9T-IT3E
Image Sensor	2 MP progressive scan CMOS	2MP CMOS Image Sensor	2MP progressive scan CMOS	2MP CMOS Image Sensor	2MP progressive scan CMOS
Effective Pixels	1920 (H) × 1080 (V)	1944(H)*1092(V)	1920 (H)*1080 (V)	1944(H)*1092(V)	1920 (H)*1080 (V)
Min. illumination	0.005 Lux @ (F1.2, AGC ON), 0 Lux with IR	Color : 0.01 Lux @(F1.2,AGC ON); B/W : 0.001 Lux @(F1.2,AGC ON)	0.003 Lux@(F1.2, AGC ON), 0 Lux with IR	0.01 Lux @ (F1.2,AGC ON),0 Lux with IR	0.003 Lux@(F1.2, AGC ON), 0 Lux with IR
Lens			2.8 mm-12 mm		2.8 mm
Day & Night		ICR	ICR	Electronic	ICR
Angle Adjustment			Pan: 0-360°, Tilt: 0-90°, Rotate: 0-360°		Pan: 0-360°, Tilt: 0-180°, Rotate: 0-360°
WDR	> 120 dB	120dB	> 120 dB	120dB	> 120 dB
Video Frame Rate	1920×1080@25fps	1080p@25fps	1080p@25fps	1080p@25fps	1080p@25fps
HD Video Output	1 Analog HD output/1 CVBS output (75Ω/BNC)	1 Analog HD output	1 Analog HD output	1 Analog HD output	1 Analog HD output
CVBS Output		1Vp-p Composite Output(75Ω/BNC)	/1 CVBS output (75Ω/BNC)	1Vp-p Composite Output(75Ω/BNC)	/1 CVBS output (75Ω/BNC)
Operating Conditions	-30 °C to 60 °C (-22 °F to 140 °F), humidity: 80% or less (non-condensation)	-30 °C – 60 °C (-22 °F – 140 °F), Humidity 90% or less (non-condensing)	-40° C to 60° C (-40° F to 140° F), humidity: 90% or less (no condensation)	-30 °C – 60 °C (-22 °F – 140 °F), Humidity 90% or less (non-condensing)	-40° C to 60° C (-40° F to 140° F), humidity: 90% or less (no condensation)
Power Supply	12 VDC ±25%-A; 24 VAC ±25%	24V±15% AC, 12V±15% DC	24 VAC/12 VDC ±30%/PoC.at	12 VDC±15%, POC	12 VDC ±30%/PoC.at
Power Consumption	Max. 3 W	Max. 6W	Max. 7.5 W	Max. 7W	Max. 4 W
Protection Level			IP67		IP67
IR Range			Up to 40 m		Up to 40 m
Dimensions	69.29 mm × 54 mm × 56 mm (2.73" × 2.13" × 2.2")	69.2×57.3×148.7mm(2.7" × 2.3" × 5.85")	92 mm × 85.3 mm ×269.6 mm (3.62" × 3.36" × 10.61")	69.2×57.3×148.7mm(2.7" × 2.3" × 5.85")	86.7 mm × 81.6 mm × 226 mm (3.4" × 3.2" × 8.9")
Weight	Approx. 175 g (0.39 lb.)	520 g	Approx. 700 g (1.54 lb.)	520 g	Approx. 800 g (1.76 lb.)

www.magazijninrichtingshop.nl - info@magazijninrichtingshop.nl - tel. +31(0)20-3633683

	VARI-FOCAL DOME CAMERA	FIXED TURRET CAMERA	PIR CAMERA	PIR CAMERA	FIXED BULLET CAMERA
Short Description	 HD1080P Ultra Low-Light PoC Dome Camera	 2 MP Ultra-Low Light PoC Turret Camera	 2 MP Ultra-Low Light PIR Bullet Camera	 NEW 2 MP Ultra-Low Light PIR Bullet Camera	 NEW 2 MP Ultra Low-Light EXIR Bullet Camera
Model	DS-2CC52D9T-AVPIT3ZE	DS-2CC52D9T-IT3E	DS-2CE11D8T-PIRL	DS-2CE12D8T-PIRL	DS-2CE16D8T-IT
Image Sensor	2MP progressive scan CMOS	2MP progressive scan CMOS	2MP progressive scan CMOS	2 MP CMOS image sensor	2MP CMOS Image Sensor
Effective Pixels	1920 (H) * 1080 (V)	1920 (H) × 1080 (V)	1920 (H) * 1080 (V)	1920 (H) × 1080 (V)	1928(H)*1088(V)
Min. illumination	0.003 Lux@(F1.2, AGC ON), 0 Lux with IR	0.003 Lux@(F1.2, AGC ON), 0 Lux with IR	0.005 Lux @ (F1.2, AGC ON), 0 Lux with IR	0.005 Lux @ (F1.2, AGC ON), 0 Lux with IR	0.005 Lux @ (F2.0, AGC ON), 0 Lux with IR
Lens	2.8 mm-12 mm	2.8 mm	2.8mm	2.8 mm	2.8mm
Day & Night	ICR	Auto/Color/B/W (White & Black)	ICR	ICR	IR cut filter
Angle Adjustment	Pan: 0-355°, Tilt: 0-75°, Rotate: 0-355°	Pan: 0-360°; Tilt:0-75°; Rotate: 0-360°	Pan: 0-360°, Tilt: 0-180°, Rotate: 0-360°	Pan: 0-360°, Tilt: 0-180°, Rotate: 0-360°	Pan: 0-360°, Tilt:0-90°, Rotate: 0-360°
WDR	> 120 dB	> 120 dB	> 120 dB	120 dB	120dB
Video Frame Rate	1080p@25fps	1080p@25fps	1080p@25fps	1080p@25fps	1080p@25fps
HD Video Output	1 Analog HD output	1 Analog HD output	1 Analog HD output	1 Analog HD output	1 Analog HD output
CVBS Output	/1 CVBS output (75Ω/BNC)	1 CVBS output (75Ω/BNC)			-
Operating Conditions	-40° C to 60° C (-40° F to 140° F), humidity: 90% or less (no condensation)	-40° C to 60° C (-40° F to 140° F), humidity: 90% or less (no condensation)	-40° C to 60° C (-40° F to 140° F), humidity: 90% or less (no condensation)	-40° C – 60 °C (-40 °F – 140 °F), Humidity 90% or less (non-condensing)	-40 °C – 60 °C (-40 °F – 140 °F), Humidity 90% or less (non-condensing)
Power Supply	24 VAC/12 VDC ±30%/PoC.at	12 VDC ±30%/PoC.af	12 V DC ±25%	12 V DC ±25%	12 VDC±25%
Power Consumption	Max. 6 W	Max. 4 W	Max. 4.5 W	Max. 4.5 W	Max. 4W
Protection Level	IP67	IP67	IP67	IP67	IP67
IR Range	Up to 40 m	Up to 40 m	Up to 20 m	Up to 20 m	Up to 20m
Dimensions	Φ 145.2 mm × 124.1 mm (7.1" × 4.9")	Φ 110 mm × 93.2 mm (4.33" × 3.67")	68 mm × 70 mm × 179.8 mm (2.68" × 2.76" × 7.08")	88.6 mm × 81.3 mm × 224.7 mm (3.49" × 3.20" × 8.85")	58 mm × 61 mm × 163 mm (2.28" × 2.40" × 6.42")
Weight	Approx. 2000 g (4.4 lb.)	Approx. 200 g (0.44 lb.)	Approx. 345 g (0.76 lb.)	Approx. 430 g (0.95 lb.)	-



VARI-FOCAL BULLET CAMERA

FIXED BULLET CAMERA

Short Description	2 MP Ultra Low-Light PoC EXIR Bullet Camera	2 MP Ultra Low-Light EXIR Bullet Camera	2 MP Ultra Low-Light VF EXIR Bullet Camera	2 MP Ultra Low-Light PoC VV EXIR Bullet Camera	2 MP Ultra Low-Light PoC EXIR Bullet Camera
Model	DS-2CE16D8T-IT3/5E	DS-2CE16D8T-IT3/IT5	DS-2CE16D8T-IT3Z	DS-2CE16D8T-IT3ZE	DS-2CE16D8T-ITE
Image Sensor	2 MP progressive scan CMOS	2MP CMOS Image Sensor	2MP progressive scan CMOS	2MP progressive scan CMOS	2 MP progressive scan CMOS
Effective Pixels	1920 (H) × 1080 (V)	1920 (H) × 1080 (V)	1920 (H)*1080 (V)	1920 (H)*1080 (V)	1920 (H) × 1080 (V)
Min. illumination	Color: 0.005 Lux @ (F2.0, AGC ON), 0 Lux with IR	0.005 Lux @ (F2.0, AGC ON), 0 Lux with IR	0.005 Lux @ (F1.2 AGC ON), 0 Lux with IR	0.005 Lux @ (F1.2 AGC ON), 0 Lux with IR	Color: 0.005 Lux @ (F2.0, AGC ON), 0 Lux with IR
Lens	2.8mm	2.8mm	2.8 mm-12 mm	2.8 mm-12 mm	2.8mm
Day & Night	IR cut filter	IR cut filter	ICR	ICR	IR cut filter
Angle Adjustment	Pan: 0-360°, Tilt: 0-90°, Rotate: 0-360°	Pan: 0-360°, Tilt: 0-180°, Rotate: 0-360°	Pan: 0-360°, Tilt: 0-90°, Rotation: 0-360°	Pan: 0-360°, Tilt: 0-90°, Rotation: 0-360°	Pan: 0-360°, Tilt: 0-90°, Rotate: 0-360°
WDR	> 120 dB	120dB	> 120 dB	> 120 dB	> 120 dB
Video Frame Rate	1080p@25fps	1080p@25fps	1080p@25fps	1080p@25fps	1080p@25fps
HD Video Output	1 HD output		1 Analog HD output	1 Analog HD output	1 HD output
CVBS Output					
Operating Conditions	-40 °C to 60 °C (-40 °F to 140 °F), humidity: 90% or less (non-condensation)	-40 °C – 60 °C (-40 °F – 140 °F), Humidity 90% or less (non-condensing)	-40° C to 60° C (-40° F to 140° F), humidity: 90% or less (no condensation)	-40° C to 60° C (-40° F to 140° F), humidity: 90% or less (no condensation)	-40 °C to 60 °C (-40 °F to 140 °F), humidity: 90% or less (non-condensation)
Power Supply	12 VDC±25%/PoC.af	12 VDC±25%	12 VDC±25%	12 VDC ±25%/PoC.at	12 VDC±25%/PoC.af
Power Consumption	Max. 4W	Max. 4W	Max. 7.5 W	Max. 8.2 W	Max. 4W
Protection Level	IP67	IP67	IP67	IP67	IP67
IR Range	Up to 20 m	Up to 40m	Up to 40 m	Up to 40 m	Up to 20 m
Dimensions	86.7 mm × 81.6 mm × 226 mm [3.41" × 3.23" × 8.67"]	86.7 mm × 81.6 mm × 226 mm [3.41" × 3.23" × 8.67"]	92 mm × 89 mm × 269.6 mm [3.62" × 3.5" × 3.34"]	92 mm × 89 mm × 269.6 mm [3.62" × 3.5" × 3.34"]	58 mm × 61 mm × 163 mm [2.28" × 2.40" × 6.42"]
Weight	Approx. 680 g (1.5 lb.)		Approx. 900 g (1.98 lb.)	Approx. 900 g (1.98 lb.)	Approx. 350 g (0.77 lb.)

www.magazijnrichtingshop.nl - info@magazijnrichtingshop.nl - tel. +31(0)20-3633683

	VARI-FOCAL BULLET CAMERA	FIXED BULLET CAMERA			VARI-FOCAL BULLET CAMERA
					
Short Description	HD1080P WDR Motorized VF EXIR Bullet Camera	5 MP Ultra-Low Light Bullet Camera	5 MP Ultra-Low Light EXIR Bullet Camera	5 MP Ultra-Low Light PoC Bullet Camera	5 MP Ultra-Low Light VF Bullet Camera
Model	DS-2CE16D9T-AIRAZH	DS-2CE16H5T-IT	DS-2CE16H5T-IT3	DS-2CE16H5T-IT3/5E	DS-2CE16H5T-IT3Z
Image Sensor	2MP CMOS Image Sensor	5 MP CMOS Image sensor	5 MP CMOS Image sensor	5 MP CMOS image sensor	5 MP CMOS Image sensor
Effective Pixels	1944(H)*1092(V)	2560 (H)*1944 (V)	2560 (H)*1944 (V)	2560 (H) x 1944 (V)	2560 (H)*1944 (V)
Min. illumination	0.01Lux @ (F1.2, AGC ON), 0 Lux with IR	0.008 Lux @ (F1.2, AGC ON), 0 Lux with IR	0.008 Lux @ (F1.2, AGC ON), 0 Lux with IR	Color: 0.008 Lux @ (F1.2, AGC ON), 0 Lux with IR	0.008 Lux @ (F1.2, AGC ON), 0 Lux with IR
Lens	5-50mm	2.8 mm	2.8 mm	3.6 mm	2.8mm-12mm
Day & Night	ICR	ICR	ICR	ICR	ICR
Angle Adjustment	Pan: 0° - 360°; Tilt: 0° - 90°; Rotate: 0° - 360°	Pan: 0-360°; Tilt: 0-180°; Rotate: 0-360°	Pan: 0-360°; Tilt: 0-180°; Rotate: 0-360°	Pan: 0-360°; Tilt: 0-180°; Rotate: 0-360°	Pan: 0-360°; Tilt: 0-90°; Rotate: 0-360°
WDR	120dB	Digital WDR	Digital WDR	Digital WDR	Digital WDR
Video Frame Rate	1080p@25fps	2560 x 1944@12.5fps, 2560 x 1440@25fps, 1920 x 1080@25fps	2560 x 1944@20fps, 2560 x 1944@12.5fps, 2560 x 1440@30fps, 2560 x 1440@25fps (default) 1920 x 1080@30fps, 1920 x 1080@25fps	2560 x 1944@12.5fps, 2560 x 1440@25fps, 1920 x 1080@25fps	2560 x 1944@12.5fps, 2560 x 1440@25fps, 1920 x 1080@25fps
HD Video Output	1 Analog HD output	1 Analog HD output	1 Analog HD output	1 Analog HD output	1 Analog HD output
CVBS Output					
Operating Conditions	-40 °C - 60 °C (-40 °F - 140 °F), Humidity 90% or less (non-condensing)	-40° C to 60° C (-40° F to 140° F), humidity: 90% or less (no condensation)	-40° C to 60° C (-40° F to 140° F), humidity: 90% or less (no condensation)	-40 °C to 60 °C (-40 °F to 140 °F), humidity: 90% or less (non-condensation)	-40° C to 60° C (-40° F to 140° F), humidity: 90% or less (no condensation)
Power Supply	AC24V±15% / DC12V±15%, Heater is available with 24VAC only	12 VDC ±25%	12 VDC ±25%	12 VDC ±25%/PoC.af	12 VDC ±25%
Power Consumption	Max. 20W	Max. 4.5 W	Max. 3.5 W	Max.4.5 W	Max. 8 W
Protection Level	IP66	IP67	IP67	IP67	IP67
IR Range	Up to 110m	Up to 20 m	Up to 40 m	Up to 40 m	Up to 40 m
Dimensions	313.5x100.8x107.3mm	58 mm x 61 mm x 163 mm [2.28" x 2.40" x 6.42"]	86.7 mm x 81.6 mm x 226 mm [3.41" x 3.23" x 8.67"]	86.7 mm x 81.6 mm x 226 mm [3.41" x 3.23" x 8.67"]	92 mm x 89 mm x 269.6 mm [3.62" x 3.5" x 10.6"]
Weight	1650g	Approx. 350 g (0.77 lb.)	Approx. 680 g (1.5 lb.)	Approx. 680 g (1.5 lb.)	Approx. 900 g (1.98 lb.)

www.magazijninrichtingshop.nl - info@magazijninrichtingshop.nl - tel: +31(0)20-3633683



NEW

FIXED BULLET CAMERA



NEW



NEW



NEW

VARI-FOCAL BULLET CAMERA

Short Description	5 MP Ultra-Low Light VF PoC Bullet Camera	5 MP Ultra-Low Light PoC Bullet Camera	4K Ultra-Low Light Bullet Camera	4K Ultra-Low Light Bullet Camera	4K Ultra-Low Light VF Bullet Camera
Model	DS-2CE16H5T-IT3ZE	DS-2CE16H5T-ITE	DS-2CE17U8T-IT	DS-2CE18U8T-IT3	DS-2CE19U8T-AIT3Z
Image Sensor	5 MP CMOS Image sensor	5 MP CMOS Image sensor	8.29 MP progressive scan CMOS	8.29 MP progressive scan CMOS	8.29 MP progressive scan CMOS
Effective Pixels	2560 (H) * 1944 (V)	2560 (H) * 1944 (V)	3840 (H) * 2160 (V)	3840 (H) * 2160 (V)	3840 (H) * 2160 (V)
Min. illumination	0.008 Lux @ (F1.2, AGC ON), 0 Lux with IR	0.008 Lux @ (F1.2, AGC ON), 0 Lux with IR	0.003 Lux@(F1.2 AGC ON), 0 Lux with IR	0.003 Lux@(F1.2, AGC ON), 0 Lux with IR	0.003 Lux@(F1.2 AGC ON), 0 Lux with IR
Lens	2.8mm-12mm	2.8 mm	2.8 mm	2.8 mm	2.8 mm-12 mm
Day & Night	ICR	ICR	ICR	ICR	ICR
Angle Adjustment	Pan: 0-360°; Tilt:0-90°; Rotate: 0-360°	Pan: 0-360°; Tilt:0-180°; Rotate: 0-360°	Pan: 0-360°, Tilt:0-180°, Rotate: 0-360°	Pan: 0-360°, Tilt:0-180°, Rotate: 0-360°	Pan: 0-360°, Tilt: 0-90°, Rotation: 0-360°
WDR	Digital WDR	Digital WDR	120 dB	120 dB	120 dB
Video Frame Rate	2560 × 1944@12.5fps, 2560×1440@25fps,1920×1080@25fps,* Under the PoC mode, 2560 × 1944@12.5fps is not available.	2560 × 1944@12.5fps, 2560×1440@25fps,1920×1080@25fps,* Under the PoC mode, 2560 × 1944@12.5fps is not available.	8 MP@12.5fps, 5 MP@20fps, 4 MP@25fps, 1080p@25fps	8 MP@12.5fps, 5 MP@20fps, 4 MP@25fps, 1080p@25fps	8 MP@12.5fps, 5 MP@20fps, 4 MP@25fps, 1080p@25fps
HD Video Output	1 Analog HD output	1 Analog HD output	1 Analog HD output	1 Analog HD output	1 Analog HD output
CVBS Output			1 CVBS output (75Ω/BNC)	1 CVBS output (75Ω/BNC)	1 CVBS output (75Ω/BNC)
Operating Conditions	-40° C to 60° C (-40° F to 140° F), humidity: 90% or less (no condensation)	-40° C to 60° C (-40° F to 140° F), humidity: 90% or less (no condensation)	-40° C to 60° C (-40° F to 140° F), humidity: 90% or less (no condensation)	-40° C to 60° C (-40° F to 140° F), humidity: 90% or less (non-condensation)	-40° C to 60° C (-40° F to 140° F), humidity: 90% or less (no condensation)
Power Supply	12 VDC ±25%/PoC.at	12 VDC ±25%/PoC.af	12 VDC ±25%	12 VDC ±25%	12 VDC ±25%, 24 VAC ±25%
Power Consumption	Max. 8 W	Max. 4.5 W	Max. 4.8 W	Max. 4.8 W	Max.14.5 W
Protection Level	IP67	IP67	IP67	IP67	IP67
IR Range	Up to 40 m	Up to 20 m	Up to 40 m	Up to 60 m	Up to 80 m
Dimensions	92 mm × 89 mm × 269.6 mm [3.62" × 3.5" × 10.6"]	58 mm × 61 mm × 163 mm [2.28" × 2.40" × 6.42"]	Ø 70 mm × 159.8 mm [Ø 2.76" × 6.29"]	2.75" × 8.85"	92 mm × 89 mm × 269.6 mm [3.62" × 3.5" × 3.34"]
Weight	Approx. 900 g (1.98 lb.)	Approx. 350 g (0.77 lb.)	Approx. 420 g (0.93 lb.)	Approx. 630 g (1.4 lb.)	Approx. 955 g (2.11 lb.)

www.magazijninrichtingshop.nl - info@magazijninrichtingshop.nl - tel: +31(0)26-36336833

PIR CAMERA





NEW

FIXED TURRET CAMERA



Short Description	2 MP Ultra-Low Light Cube Camera	2 MP Ultra Low-Light EXIR Turret Camera	2 MP Ultra Low-Light PoC EXIR Turret Camera	2 MP Ultra Low-Light EXIR Turret Camera	2 MP Ultra-Low Light PoC Turret Camera
Model	DS-2CE38D8T-PIR	DS-2CE56D8T-IT1/3	DS-2CE56D8T-IT3E	DS-2CE56D8T-ITM	DS-2CE56D8T-ITME
Image Sensor	2MP progressive scan CMOS	2MP CMOS Image Sensor	2 MP progressive scan CMOS	2MP CMOS Image Sensor	2MP CMOS Image Sensor
Effective Pixels	1920 (H) × 1080 (V)	1920 (H) × 1080 (V)	1920 (H) × 1080 (V)	1920 (H) × 1080 (V)	1920 (H) × 1080 (V)
Min. illumination	0.005 Lux @ (F1.2, AGC ON), 0 Lux with IR	0.005 Lux @ (F2.0 AGC ON), 0 Lux with IR	Color: 0.005 Lux @ (F2.0, AGC ON), 0 Lux with IR	0.01 Lux @ (F1.2, AGC ON), 0 Lux with IR	0.01 Lux @ (F1.2, AGC ON), 0 Lux with IR
Lens	2.8 mm	2.8mm	2.8mm	2.8mm	2.8mm
Day & Night	ICR	IR cut filter	IR cut filter	IR cut filter	ICR
Angle Adjustment		Pan: 0-360°, Tilt: 0-75°, Rotate: 0-360°	Pan: 0-360°, Tilt:0-90°, Rotate: 0-360°	Pan: 0-360°, Tilt:0-75°, Rotate: 0-360°	Pan: 0-360°, Tilt:0-75°, Rotate: 0-360°
WDR	> 120 dB	120dB	> 120 dB	120dB	120dB
Video Frame Rate	1080p@25fps	1080p@25fps	1080p@25fps	1080p@25fps	1080p@25fps
HD Video Output	1 Analog HD output		1 HD output	1 HD output	1 Analog HD output
CVBS Output					
Operating Conditions	-40° C to 60° C [-40° F to 140° F], humidity: 90% or less (no condensation)	-40° C – 60° C [-40° F – 140° F], Humidity 90% or less (non-condensing)	-40° C to 60° C [-40° F to 140° F], humidity: 90% or less (non-condensation)	-40° C – 60° C [-40° F – 140° F], Humidity 90% or less (non-condensing)	-40° C – 60° C [-40° F – 140° F], Humidity 90% or less (non-condensing)
Power Supply	12 VDC ±30%/PoC.af	12 V DC ±25%	12 VDC±25%/PoC.af	12 V DC ±25%	12 V DC ±25%/PoC.af
Power Consumption	Max. 5 W	Max. 3.5 W	Max. 4W	Max. 3.5 W	Max. 3.6 W
Protection Level		IP67	IP67	IP67	IP67
IR Range	Up to 20 m	Up to 20 m	Up to 40 m	Up to 20 m	Up to 20 m
Dimensions	104 mm × 66 mm × 41.07 mm (4.1" × 2.6" × 1.62")	Φ 110 mm × 93.2 mm (Φ 4.33" × 3.67")	Φ 110 mm × 93.2 mm (Φ 4.33" × 3.67")	91 mm × 82.6 mm × 68.3 mm (3.58" × 3.25" × 2.69")	91 mm × 82.6 mm × 68.3 mm (3.58" × 3.25" × 2.69")
Weight	Approx. 210 g (0.46 lb.)		350 g (0.77 lb.)		Approx. 350 g (0.77 lb.)

www.magazijninrichtingshop.nl - info@magazijninrichtingshop.nl - tel: +31(0)20-3633683

	FIXED DOME CAMERA	VARI-FOCAL DOME CAMERA	FIXED DOME CAMERA	VARI-FOCAL DOME CAMERA	FIXED TURRET CAMERA
Short Description	 2 MP Ultra Low-Light EXIR Dome Camera	 2 MP Ultra-Low Light VF Dome Camera	 NEW 2 MP Ultra Low-Light PoC EXIR Dome Camera	 5 MP Ultra-Low Light VF Dome Camera	 5 MP Ultra-Low Light Turret Camera
Model	DS-2CE56D8T-VPIT	DS-2CE56D8T-VPIT3Z	DS-2CE56D8T-VPITE	DS-2CE56H5T-AVPIT3Z	DS-2CE56H5T-IT3
Image Sensor	2MP progressive scan CMOS	2MP progressive scan CMOS	2MP progressive scan CMOS	5 MP CMOS Image sensor	5 MP CMOS Image sensor
Effective Pixels	1920 (H) * 1080 (V)	1920 (H) × 1080 (V)	1920 (H) * 1080 (V)	2560 (H) * 1944 (V)	2560 (H) * 1944 (V)
Min. illumination	0.005 Lux @ (F1.2, AGC ON), 0 Lux with IR	Color: 0.005 Lux @ (F1.2, AGC ON), 0 Lux with IR	0.005 Lux @ (F1.2, AGC ON), 0 Lux with IR	0.008 Lux @ (F1.2, AGC ON), 0 Lux with IR	0.008 Lux @ (F1.2, AGC ON), 0 Lux with IR
Lens	2.8 mm	2.8-12mm	2.8 mm, 3.6 mm	2.8mm-12mm	2.8 mm
Day & Night	IR cut filter	ICR	IR cut filter	ICR	ICR
Angle Adjustment	Pan: 0-355°, Tilt:0-75°, Rotate: 0-355°	Pan: 0-340°, Tilt:0-75°, Rotate: 0-355°	Pan: 0-355°, Tilt:0-75°, Rotate: 0-355°	Pan: 0-355°; Tilt:0-75°; Rotate: 0-355°	Pan: 0-360°; Tilt:0-75°; Rotate: 0-360°
WDR	> 120 dB	> 120 dB	> 120 dB	Digital WDR	Digital WDR
Video Frame Rate	1080p@25fps	1080p@25fps	1080p@25fps	2560 × 1944@20fps, 2560 × 1944@12.5fps 2560 × 1440@30fps, 2560 × 1440@25fps (default) 1920 × 1080@30fps, 1920 × 1080@25fps	2560 × 1944@20fps, 2560 × 1944@12.5fps, 2560 × 1440@30fps, 2560 × 1440@25fps (default) 1920 × 1080@30fps, 1920 × 1080@25fps
HD Video Output	1 HD output	1 Analog HD output	1 Analog HD output	1 Analog HD output	1 Analog HD output
CVBS Output					
Operating Conditions	-40 °C to 60 °C (-40 °F to 140 °F), humidity: 90% or less (non-condensation)	-40 °C to 60 °C (-40 °F to 140 °F), humidity: 90% or less (non-condensation)	-40 °C to 60 °C (-40 °F to 140 °F), humidity: 90% or less (non-condensation)	-40 °C to 60 °C (-40 °F to 140 °F), humidity: 90% or less (no condensation)	-40 °C to 60 °C (-40 °F to 140 °F), humidity: 90% or less (non-condensation)
Power Supply	12 VDC±25%	12 VDC ±25%-A: 12 VDC ±25%, 24 VAC ±25%	12 VDC±25%/PoC.af	12 VDC ±25%, 24 V AC ±25%	12 V DC ±25%
Power Consumption	Max. 3.5 W	Max. 5.5 W-A: Max. 7 W	Max. 3.2 W	Max. 6 W	Max.3.5 W
Protection Level	IP67, IK7	IP67, IK10	IP67, IK7	IP67	IP67
IR Range	Up to 20 m	Up to 40 m	Up to 20 m	Up to 40 m	Up to 40 m
Dimensions	Φ 111 mm × 82.4 mm (Φ 4.4" × 3.2")	Φ 145.2 mm × 124.1 mm (Φ 5.72" × 4.89")	Φ 111 mm × 82.4 mm (Φ 4.4" × 3.2")	Φ 145.2 mm × 124.1 mm (Φ 5.72" × 4.89")	Φ 110 mm × 93.2 mm (Φ 4.33" × 3.67")
Weight	Approx. 350 g (0.77 lb.)	Approx. 1600 g (3.53 lb.)	Approx. 350 g (0.77 lb.)	Approx. 1600 g (3.53 lb.)	350 g (0.77 lb.)

www.magazijninrichtingshop.nl - info@magazijninrichtingshop.nl - tel. +31(0)20-3633683

VARI-FOCAL TURRET CAMERA



NEW

FIXED TURRET CAMERA



NEW

VARI-FOCAL BULLET CAMERA



NEW

Short Description

5 MP Ultra-Low Light VF Turret Camera

5 MP Ultra-Low Light VF PoC Turret Camera

5 MP Ultra-Low Light Turret Camera

5 MP Ultra-Low Light PoC Turret Camera

5 MP Ultra-Low Light VF PoC Dome Camera

Model	DS-2CE56H5T-IT3Z	DS-2CE56H5T-IT3ZE	DS-2CE56H5T-ITM	DS-2CE56H5T-ITME	DS-2CE56H5T-VPIT3ZE
Image Sensor	5 MP CMOS Image sensor	5 MP CMOS Image sensor	5 MP CMOS Image sensor	5 MP CMOS Image sensor	5 MP CMOS Image sensor
Effective Pixels	2560 (H)*1944 (V)	2560 (H)*1944 (V)	2560 (H)*1944 (V)	2560 (H)*1944 (V)	2560 (H)*1944 (V)
Min. illumination	0.008 Lux @ (F1.2, AGC ON), 0 Lux with IR	0.008 Lux @ (F1.2, AGC ON), 0 Lux with IR	0.008 Lux @ (F1.2, AGC ON), 0 Lux with IR	0.008 Lux @ (F1.2, AGC ON), 0 Lux with IR	0.008 Lux @ (F1.2, AGC ON), 0 Lux with IR
Lens	2.8mm-12mm	2.8mm-12mm	2.8 mm	2.8 mm	2.8mm-12mm
Day & Night	ICR	ICR	ICR	ICR	ICR
Angle Adjustment	Pan: 0-360°; Tilt:0-75°; Rotate: 0-360°	Pan: 0-360°; Tilt:0-75°; Rotate: 0-360°	Pan: 0-360°; Tilt:0-75°; Rotate: 0-360°	Pan: 0-360°; Tilt:0-75°; Rotate: 0-360°	Pan: 0-355°; Tilt:0-75°; Rotate: 0-355°
WDR	Digital WDR	Digital WDR	Digital WDR	Digital WDR	Digital WDR
Video Frame Rate	2560 × 1944@20fps, 2560 × 1944@12.5fps, 2560 × 1440@30fps, 2560 × 1440@25fps (default) 1920×1080@30fps, 1920×1080@25fps	2560 × 1944@12.5fps, 2560 × 1440@25fps, 1920×1080@25fps, * Under the PoC mode, 2560 × 1944@12.5fps is not available.	2560 × 1944@20fps, 2560 × 1944@12.5fps, 2560 × 1440@30fps, 2560 × 1440@25fps (default) 1920×1080@30fps, 1920×1080@25fps	2560 × 1944@12.5fps, 2560 × 1440@25fps, 1920×1080@25fps, * Under the PoC mode, 2560 × 1944@12.5fps is not available.	2560 × 1944@12.5fps, 2560 × 1440@25fps, 1920×1080@25fps, * Under the PoC mode, 2560 × 1944@12.5fps is not available.
HD Video Output	1 Analog HD output	1 Analog HD output	1 Analog HD output	1 Analog HD output	1 Analog HD output
CVBS Output					
Operating Conditions	-40 °C to 60 °C (-40 °F to 140 °F), humidity: 90% or less (non-condensation)	-40° C to 60° C (-40° F to 140° F), humidity: 90% or less (no condensation)	-40 °C to 60 °C (-40 °F to 140 °F), humidity: 90% or less (non-condensation)	-40 °C to 60 °C (-40 °F to 140 °F), humidity: 90% or less (no condensation)	-40° C to 60° C (-40° F to 140° F), humidity: 90% or less (no condensation)
Power Supply	12 V DC ±25%	12 VDC ±25%/PoC.at	12 V DC ±25%	12 VDC ±25%/PoC.af	12 VDC ±25%/PoC.at
Power Consumption	Max. 9 W	Max. 8 W	Max.3.5 W	Max.4.5 W	Max. 8 W
Protection Level	IP67	IP67	IP67	IP67	IP67
IR Range	Up to 40 m	Up to 40 m	Up to 20 m	Up to 40 m	Up to 40 m
Dimensions	134.3 mm × 123.9 mm × 110.1 mm (5.29" × 4.88" × 4.38")	134.3 mm × 123.9 mm × 110.1 mm (5.29" × 4.88" × 4.38")	91 mm × 82.6 mm × 68.3 mm (3.58" × 3.25" × 2.69")	91 mm × 82.6 mm × 68.3 mm (3.58" × 3.25" × 2.69")	Φ 145.2 mm × 124.1 mm (Φ 5.72" × 4.89")
Weight	Approx. 750 g (1.57 lb.)	Approx. 750 g (1.57 lb.)	Approx. 350 g (0.77 lb)	Approx. 350 g (0.77 lb)	Approx. 1600 g (3.53 lb.)

www.magazijninrichtingshop.nl - info@magazijninrichtingshop.nl - tel. +31(0)20-3633083

	VARI-FOCAL DOME CAMERA	FIXED DOME CAMERA	PIR CAMERA	FIXED TURRET CAMERA	VARI-FOCAL TURRET CAMERA
	 NEW	 NEW	 NEW	 NEW	 NEW
Short Description	4K Ultra-Low Light VF Dome Camera	2 MP Ultra-Low Light VF Dome Camera	2 MP Ultra-Low Light PIR Turret Camera	4K Ultra-Low Light Turret Camera	4K Ultra-Low Light VF Turret Camera
Model	DS-2CE59U8T-AVPIT3Z	DS-2CE5AD8T-VPIT3Z	DS-2CE71D8T-PIRL	DS-2CE78U8T-IT3	DS-2CE79U8T-IT3Z
Image Sensor	8.29 MP progressive scan CMOS	2MP progressive scan CMOS	2MP progressive scan CMOS	8.29 MP progressive scan CMOS	8.29 MP progressive scan CMOS
Effective Pixels	3840 (H) * 2160 (V)	1920 (H) × 1080 (V)	1920 (H) * 1080 (V)	3840 (H) × 2160 (V)	3840 (H) * 2160 (V)
Min. illumination	0.003 Lux@(F1.2, AGC ON), 0 Lux with IR	0.005 Lux @ (F1.2, AGC ON), 0 Lux with IR	0.005 Lux @ (F1.2, AGC ON), 0 Lux with IR	Color: 0.003 Lux@(F1.2, AGC ON), 0 Lux with IR	0.003 Lux@(F1.2 AGC ON), 0 Lux with IR
Lens	2.8 mm-12 mm	2.8 mm-12 mm	2.8mm	2.8 mm	2.8 mm-12 mm
Day & Night	ICR	ICR	ICR	ICR	ICR
Angle Adjustment	Pan: 0-355°, Tilt:0-75°, Rotate: 0-355°	Pan: 0-355°, Tilt:0-70°, Rotate: 0-355°	Pan: 0-360°, Tilt: 0-75°, Rotate: 0-360°	Pan: 0-360°, Tilt: 0-75°, Rotate: 0-360°	Pan: 0-355°, Tilt:0-75°, Rotate: 0-355°
WDR	120 dB	120dB	> 120 dB	> 120 dB	120 dB
Video Frame Rate	8 MP@12.5fps, 5 MP@20fps, 4 MP@25fps, 1080p@25fps	1080p@25fps	1080p@25fps	8 MP@12.5fps, 5 MP@20fps, 4 MP@25fps, 1080p@25fps	8 MP@12.5fps, 5 MP@20fps, 4 MP@25fps, 1080p@25fps
HD Video Output	1 Analog HD output	1 Analog HD output	1 Analog HD output	1 Analog HD output	1 Analog HD output
CVBS Output	1 CVBS output (75Ω/BNC)			1 CVBS output (75Ω/BNC)	1 CVBS output (75Ω/BNC)
Operating Conditions	-40° C to 60° C (-40° F to 140° F), humidity: 90% or less (no condensation)	-40° C - 60° C (-40° F - 140° F), Humidity 90% or less (non-condensing)	-40° C to 60° C (-40° F to 140° F), humidity: 90% or less (no condensation)	-40° C to 60° C (-40° F to 140° F), humidity: 90% or less (non-condensation)	-40° C to 60° C (-40° F to 140° F), humidity: 90% or less (no condensation)
Power Supply	12 VDC ±25%, 24 VDC ±25%	12 V DC ±25%	12 V DC ±25%	12 VDC ±25%	12 VDC ±25%
Power Consumption	Max. 10.5 W	Max. 6 W	Max. 4.5 W	Max. 4.8 W	Max.14 W
Protection Level	IP67	IP67	IP67	IP67	IP67
IR Range	Up to 60 m	Up to 40 m	Up to 20 m	Up to 60 m	Up to 80 m
Dimensions	Φ 145.2 mm × 124.1 mm (Φ 5.72" × 4.89")	Ø 141 mm × 99.9 mm (Ø 5.55" × 3.93")	Ø 109.8 mm × 89.75 mm (Ø 4.32" × 3.53")	Ø 109.8 mm × 96.3 mm (Ø 4.32" × 3.79")	134.3 mm × 123.9 mm × 111.4 mm (5.29" × 4.88" × 4.39")
Weight	Approx. 645 g (1.42 lb.)	Approx. 800 g (1.76 lb.)	Approx. 310 g (0.68 lb.)	Approx. 360 g (0.79 lb.)	Approx. 630 g (1.39 lb.)

www.magazijnrichtingshop.nl - info@magazijnrichtingshop.nl - tel: +31(0)26-3633683

PINHOLE CAMERA



Short Description	2 MP WDR Covert Camera
Model	DS-2CS54D8T-PH
Image Sensor	2 MP progressive scan CMOS
Effective Pixels	1920 (H) × 1080 (V)
Min. illumination	0.005 Lux @ (F1.2, AGC ON), 0 Lux with IR
Lens	3.7 mm
Day & Night	Electronic
Angle Adjustment	
WDR	> 120 dB
Video Frame Rate	1920×1080@25fps
HD Video Output	1 Analog HD output/1 CVBS output (75Ω/BNC)
CVBS Output	
Operating Conditions	-40° C to 60° C (-40° F to 140° F), Humidity 90% or less (no condensation)
Power Supply	12 VDC ±20%
Power Consumption	Max. 1.5 W
Protection Level	
IR Range	
Dimensions	32.4 mm × 32.4 mm × 22.0 mm (1.28" × 1.28" × 0.87")
Weight	Approx. 200 g (0.44 lb.)

www.magazijninrichtingshop.nl - info@magazijninrichtingshop.nl - tel. +31(0)26-3633683



TURBO HD PTZ CAMERAS

Not only do our PTZ cameras deliver an incredible image during daytime scenes, they also produce clear images- down to 0.02 lux. The series includes autofocus zoom lenses that yields up to 37x optical zoom! It is designed for installations that do not require the 360° high speed positioning of traditional PTZ cameras but that do need occasional pan/tilt/zoom capabilities, including presets, patrols and patterns. The series boasts IP66 and IK10 ratings, allowing the cameras to be mounted in both in- and outdoor installations.

www.magazijninrichtingshop.nl - info@magazijninrichtingshop.nl - tel. +31(0)26-3633683

1920×1080



NEW



NEW



NEW



NEW



NEW

Short Description	2 MP Turbo 4-Inch Speed Dome	2 MP Turbo 4-Inch Speed Dome	2 MP IR Turbo 4-Inch Speed Dome	2 MP Turbo 4-Inch Speed Dome	2 MP IR Turbo 4-Inch Speed Dome
Model	DS-2AE4215T-D	DS-2AE4215T-D3	DS-2AE4215TI-D	DS-2AE4225T-D	DS-2AE4225TI-D
Image Sensor	1/2.8" progressive scan CMOS	1/2.8" progressive scan CMOS	1/2.8" progressive scan CMOS	1/2.8" progressive scan CMOS	1/2.8" progressive scan CMOS
Min. Illumination	Color: 0.005 Lux @(F1.6, AGC ON)B/W: 0.001 Lux @(F1.6, AGC ON)	Color: 0.005 Lux @(F1.6, AGC ON)B/W: 0.001 Lux @(F1.6, AGC ON)	Color: 0.005 Lux @(F1.6, AGC ON)B/W: 0.001 Lux @(F1.6, AGC ON) lux with IR	Color: 0.005 Lux @(F1.6, AGC ON)B/W: 0.001 Lux @(F1.6, AGC ON)	Color: 0.005 Lux @(F1.6, AGC ON)B/W: 0.001 Lux @(F1.6, AGC ON) lux with IR
Max. Image Resolution	1920×1080	1920×1080	1920×1080	1920×1080	1920×1080
Focal Length	5 mm to 75 mm	5 mm to 75 mm	5 mm to 75 mm	4.8 mm to 120 mm	4.8 mm to 120 mm
Zoom Speed	Approx. 2.4 s (optical, wide to tele)	Approx. 2.4 s (optical, wide to tele)	Approx. 2.4 s (optical, wide to tele)	Approx. 3.2 s (optical, wide to tele)	Approx. 3.2 s (optical, wide to tele)
Angle of View	53.8° to 4.0° (wide to tele)	53.8° to 4.0° (wide to tele)	53.8° to 4.0° (wide-tele)	57.6° to 2.5° (wide to tele)	57.6° to 2.5° (wide-tele)
Aperture Range	F 1.6 to F 3.5	F 1.6 to F 3.5	F 1.6 to F 3.5	F 1.6 to F 3.5	F 1.6 to F 3.5
Focus Mode	Auto/Semiauto/Manual	Auto/Semiauto/Manual	Auto/Semiauto/Manual	Auto/Semiauto/Manual	Auto/Semiauto/Manual
DWDR	DWDR	DWDR	DWDR	WDR (≥120dB)	WDR (≥120dB)
Day & Night	IR cut filter	IR cut filter	IR cut filter	IR cut filter	IR cut filter
Range	Pan:360° endless;Tilt:5° to 90° (auto flip)	Pan:360° endless;Tilt:5° to 90° (auto flip)	Pan:360° endless;Tilt:-15° to 90° (auto flip)	Pan:360° endless;Tilt:5° to 90° (auto flip)	Pan:360° endless;Tilt:-15° to 90° (auto flip)
Speed	Pan manual speed: 0.1° to 100°/sPan preset speed: 100°/s Tilt manual speed: 0.1° to 80°/sTilt preset speed: 80°/s	Pan manual speed: 0.1° to 100°/sPan preset speed: 100°/s Tilt manual speed: 0.1° to 80°/sTilt preset speed: 80°/s	Pan manual speed: 0.1° to 80°/sPan preset speed: 80°/s Tilt manual speed: 0.1° to 80°/sTilt preset speed: 80°/s	Pan manual speed: 0.1° to 100°/sPan preset speed: 100°/s Tilt manual speed: 0.1° to 80°/sTilt preset speed: 80°/s	Pan manual speed: 0.1° to 80°/sPan preset speed: 80°/s Tilt manual speed: 0.1° to 80°/sTilt preset speed: 80°/s
Number of Preset	-	-	-	-	-
IR Distance	NA	NA	100m	NA	100m
Power	12V DCMMax. 12 W	12V DCMMax. 12 W	12 VDCMax.20 W (IR:7 W)	12 VDCMax. 16 W	12 VDCMax.20 W (IR:7 W)
Working Temperature	Temperature:-10° C to 50° C (14° F to 122° F)	Temperature:-10° C to 50° C (14° F to 122° F)	Temperature:-30° C to 65° C (-22° F to 149° F)	Temperature:-30° C to 65° C (-22° F to 149° F)	Temperature:-30° C to 65° C (-22° F to 149° F)
Protection Level	IP66 standard (outdoor dome)TVS 4,000 V lightning protection, surge protection and voltage transient protection	IP66 standard (outdoor dome)TVS 4,000 V lightning protection, surge protection and voltage transient protection	IP66 standard (outdoor dome)TVS 4,000 V lightning protection, surge protection and voltage transient protection	IP66 standard (outdoor dome)TVS 4,000 V lightning protection, surge protection and voltage transient protection	IP66 standard (outdoor dome)TVS 4,000 V lightning protection, surge protection and voltage transient protection



NEW



NEW



NEW



NEW



NEW

Short Description	2 MP Turbo 5-Inch Speed Dome	2 MP IR Turbo 5-Inch Speed Dome	2 MP IR Turbo 5-Inch Speed Dome	2 MP Turbo 5-Inch Speed Dome	2 MP IR Turbo 7-Inch Speed Dome
Model	DS-2AE5225T-A	DS-2AE5225T-A3	DS-2AE5225TI-A	DS-2AE5232T-A	DS-2AE7225TI-A
Image Sensor	1/2.8" progressive scan CMOS	1/2.8" progressive scan CMOS	1/2.8" progressive scan CMOS	1/2.8" progressive scan CMOS	1/2.8" progressive scan CMOS
Min. Illumination	Color: 0.005 Lux @(F1.6, AGC ON)B/W: 0.001 Lux @(F1.6, AGC ON)0 lux with IR	Color: 0.005 Lux @(F1.6, AGC ON)B/W: 0.001 Lux @(F1.6, AGC ON)0 lux with IR	Color: 0.005 Lux @(F1.6, AGC ON)B/W: 0.001 Lux @(F1.6, AGC ON)0 lux with IR	Color: 0.005 Lux @(F1.6, AGC ON)B/W: 0.001 Lux @(F1.6, AGC ON)0 lux with IR	Color: 0.005 Lux @(F1.6, AGC ON)B/W: 0.001 Lux @(F1.6, AGC ON)0 lux with IR
Max. Image Resolution	1920×1080	1920×1080	1920×1080	1920×1080	1920×1080
Focal Length	4.8 mm to 120 mm	4.8 mm to 120 mm	4.8 mm to 120 mm	4.8 mm to 153 mm	4.8 mm to 120 mm
Zoom Speed	Approx. 3.2 s (optical, wide to tele)	Approx. 3.2 s (optical, wide to tele)	Approx. 3.2 s (optical, wide to tele)	Approx. 3.5 s (optical, wide to tele)	Approx. 3.2 s (optical, wide to tele)
Angle of View	57.6° to 2.5° (wide-tele)	57.6° to 2.5° (wide-tele)	57.6° to 2.5° (wide-tele)	54.2° to 1.97° (wide-tele)	57.6° to 2.5° (wide-tele)
Aperture Range	F 1.6 to F 3.5	F 1.6 to F 3.5	F 1.6 to F 3.5	F 1.6 to F4.6	F 1.6 to F 3.5
Focus Mode	Auto/Semiauto/Manual	Auto/Semiauto/Manual	Auto/Semiauto/Manual	Auto/Semiauto/Manual	Auto/Semiauto/Manual
DWDR	WDR (≥120dB)	WDR (≥120dB)	WDR (≥120dB)	DWDR	WDR (≥120dB)
Day & Night	IR cut filter	IR cut filter	IR cut filter	IR cut filter	IR cut filter
Range	Pan:360° endless;Tilt:-15° to 90° (auto flip)	Pan:360° endless;Tilt:-15° to 90° (auto flip)	Pan:360° endless;Tilt:-15° to 90° (auto flip)	Pan:360° endless;Tilt:-15° to 90° (auto flip)	Pan:360° endless;Tilt:-15° to 90° (auto flip)
Speed	Pan manual speed: 0.1° to 120°/sPan preset speed: 120°/s Tilt manual speed: 0.1° to 80°/sTilt preset speed: 80°/s	Pan manual speed: 0.1° to 120°/sPan preset speed: 120°/s Tilt manual speed: 0.1° to 80°/sTilt preset speed: 80°/s	Pan manual speed: 0.1° to 120°/sPan preset speed: 120°/s Tilt manual speed: 0.1° to 80°/sTilt preset speed: 80°/s	Pan manual speed: 0.1° to 120°/sPan preset speed: 120°/s Tilt manual speed: 0.1° to 80°/sTilt preset speed: 80°/s	Pan manual speed: 0.1° to 120°/sPan preset speed: 120°/s Tilt manual speed: 0.1° to 80°/sTilt preset speed: 80°/s
Number of Preset	-	-	-	-	-
IR Distance	NA	NA	150m	NA	150m
Power	24 VACMax.24 W	24 VACMax. 18 W	24 VACMax.30 W (IR:10 W)	24 VACMax. 24 W	24 VACMax.30 W (IR:10 W)
Working Temperature	Temperature:-30° C to 65° C (-22° F to 149° F)	Temperature:-10° C to 50° C (14° F to 122° F)	-30° C to 65° C (-22° F to 149° F)	Temperature:-30° C to 65° C (-22° F to 149° F)	-30° C to 65° C (-22° F to 149° F)
Protection Level	IP66 standard (outdoor dome)TVS 4,000 V lightning protection, surge protection and voltage transient protection	IP66 standard (outdoor dome)TVS 4,000 V lightning protection, surge protection and voltage transient protection	IP66 standard (outdoor dome)TVS 4,000 V lightning protection, surge protection and voltage transient protection	IP66 standard (outdoor dome)TVS 4,000 V lightning protection, surge protection and voltage transient protection	IP66 standard (outdoor dome)TVS 4,000 V lightning protection, surge protection and voltage transient protection

www.magazijnrichtingshop.nl - tel: +31(0)26-3633683 - info@magazijnrichtingshop.nl



Short Description	2 MP IR Turbo 7-Inch Speed Dome
Model	DS-2AE7232TI-A
Image Sensor	1/2.8" progressive scan CMOS
Min. Illumination	Color: 0.005 Lux @(F1.6, AGC ON)/W: 0.001 Lux @(F1.6, AGC ON)0 lux with IR
Max. Image Resolution	1920×1080
Focal Length	4.8 mm to 153 mm
Zoom Speed	Approx. 3.5 s (optical, wide to tele)
Angle of View	54.2° to 1.97°(wide-tele)
Aperture Range	F 1.6 to F 4.6
Focus Mode	Auto/Semiauto/Manual
DWDR	DWDR
Day & Night	IR cut filter
Range	Pan:360° endless; Tilt:-15° to 90° (auto flip)
Speed	Pan manual speed: 0.1° to 160°/sPan preset speed: 160°/s Tilt manual speed: 0.1° to 120°/sTilt preset speed: 120°/s
Number of Preset	-
IR Distance	150m
Power	24 VACMax. 40 W (IR:14 W)
Working Temperature	Temperature:-30° C to 65° C (-22° F to 149° F)
Protection Level	IP66 standard (outdoor dome)TVS 4,000 V lightning protection, surge protection and voltage transient protection

www.magazijninrichtingshop.nl - info@magazijninrichtingshop.nl - tel. +31(0)26-3633683



H.265+ GREAT PERFORMANCE

LOW BANDWIDTH

Hikvision lifts video surveillance to an unprecedented level with its H.265+ codec. In Full HD mode, H.265+ uses less than 20% of the bandwidth of H.264, allowing for live streams of unrivalled quality.

MINIMUM STORAGE

H.265+ also greatly outperforms all its predecessors in terms of storage. Regardless of environment or application, H.265+ reduces the required storage space by more than 80%.

In short, H.265+ allows you to kill two birds with one stone: you can now record images at amazingly high resolutions and minimize the required storage capacity. This makes H.265+ the ideal solution for 24-hour surveillance!

DIGITAL VIDEO RECORDERS (DVRS)

Because Hikvision realises that not all solutions are based on IP technology, we evolve existing technologies to provide the widest range of products to for all applications. This can be seen in the state-of-the-art DVR products, which offer the best of both worlds.

The products are split into two series to maximise application flexibility: the Professional Series, boasting powerful products with a range of feature, including Hikvision's unique H.265+ codec and PoC technology; and the Economic Series, offering reliable technology with a more limited feature set for lower budgets.

DVR SERIES

HGHI-F series	TurboHD 3.0
7100HGHI-Kx	- Max 720p analogue input - Up to 8 channel
HTHI-K series	TurboHD 4.0
7200HTHI-Kx	- Max 8MP analogue input - Up to 16 channel - VCA support
HUHI-K series	TurboHD 4.0
7200HUHI-Kx	- Max 5MP analogue input - Up to 16 channel - VCA support
HQHI-K series	TurboHD 4.0
7200HQHI-Kx 7100HQHI-Kx	- Max 3MP analogue input - Up to 16 channel - VCA support

www.magazijninrichtingshop.nl - info@magazijninrichtingshop.nl - tel. +31(0)26-3633683

MINI 1U CHASSIS



NEW

Short Description	DS-7100HGHI-F1 series TURBO HD DVR	DS-7100HQHI-K1 SERIES TURBO HD DVR
Model	DS-7100HGHI-F1	DS-7100HQHI-Kx
Video compression	H.264+/H.264	H.265+/H.265/H.264+/H.264
Analog video input	4-ch	4-ch
HD-TVI video input	1080p25, 1080p30, 720p25, 720p30	3 MP, 1080p25, 1080p30, 720p25, 720p30, 720p50, 720p60Note: The 3 MP signal input is only available for channel 1 of DS-7104HQHI-K1
IP video input		1-ch(Up to 4 MP resolution)
Audio compression	G.711u	G.711u
Audio input	1-ch ,RCA (2.0 Vp-p, 1 KΩ)	1-ch, RCA (2.0 Vp-p, 1 KΩ)
Two-way audio in	1-ch ,RCA (2.0 Vp-p, 1 KΩ)	1-ch, RCA (2.0 Vp-p, 1 KΩ)
HDMI/VGA output	1-ch, 1920 × 1080/60Hz, 1280 × 1024/60Hz, 1280 × 720/60Hz, 1024 × 768/60Hz	1-ch, 1920 × 1080/60Hz, 1280 × 1024/60Hz, 1280 × 720/60Hz, 1024 × 768/60Hz
CVBS output		
Encoding resolution	When 1080p Lite mode not enabled: 720p/WD1/4CIF/VGA/CIFWhen 1080p Lite mode enabled: 1080p lite/720p/WD1/4CIF/VGA/CIF	When 1080p Lite mode not enabled: 3 MP/1080p/720p/WD1/4CIF/VGA/CIF;When 1080p Lite mode enabled: 3 MP/1080p lite/720p lite/WD1/4CIF/VGA/CIF
Video bitrate	32 Kbps to 4 Mbps	32 Kbps to 6 Mbps
Audio output	1-ch, RCA (Linear, 1 KΩ)	1-ch, RCA (Linear, 1 KΩ)
Audio bitrate	64 Kbps	64 Kbps
Synchronous playback	4-ch	4-ch
SATA	1 SATA interface	1 SATA interface
Capacity	Up to 6 TB capacity for each disk	Up to 4 TB capacity for each disk
Network interface	1, RJ45 10M/100M self-adaptive Ethernet interface	1, RJ45 10M/100M self-adaptive Ethernet interface
USB port	Rear panel: 2 × USB 2.0	Real panel: 2 × USB 2.0
Alarm in/out		
Power supply	12 VDC	12 VDC
Working temperature	10 °C to +55 °C (14 °F to 131 °F)	-10 °C to +55 °C (+14 °F to +131 °F)
Working humidity	10% to 90%	10% to 90%
Dimensions(W × D × H)	200 × 200 × 45 mm (7.9 × 7.9 × 1.8 inch)	200 × 200 × 45 mm (7.9 × 7.9 × 1.8 inch)

www.magazijninrichtingshop.nl - info@magazijninrichtingshop.nl - tel. +31(0)26-3633683

1U CHASSIS



Short Description	DS-7200HGHI-F1 SERIES TURBO HD DVR	DS-7200HQHI-K1 SERIES TURBO HD DVR	DS-7200HQHI-K1 SERIES TURBO HD DVR
Model	DS-7200HGHI-Fx	DS-7200HQHI-Kx	DS-7200HQHI-Kx(/A)
Video compression	H.264+/H.264	H.265+/H.265/H.264+/H.264	H.265+/H.265/H.264+/H.264
Analog video input	4-ch	16-ch	4-ch
HD-TVI video input	1080p25, 1080p30, 720p25, 720p30	4 MP, 3 MP, 1080p30, 1080p25, 720p60, 720p50, 720p30, 720p25	4 MP, 3 MP, 1080p30, 1080p25, 720p60, 720p50, 720p30, 720p25
IP video input	1-ch, Up to 960p resolution	2-ch (Up to 4 MP resolution)	1-ch (Up to 4 MP resolution)
Audio compression	G.711u	G.711u	G.711u
Audio input	1-ch, RCA (2.0 Vp-p, 1 KΩ)	1-ch, RCA (2.0 Vp-p, 1 KΩ)	1-ch, RCA (2.0 Vp-p, 1 KΩ)
Two-way audio in	1-ch, RCA (2.0 Vp-p, 1 KΩ)	1-ch, RCA (2.0 Vp-p, 1 KΩ) (using the 1st audio input)	1-ch, RCA (2.0 Vp-p, 1 KΩ) (using the 1st audio input)
HDMI/VGA output	1-ch, 1920 × 1080/60Hz, 1280 × 1024/60Hz, 1280 × 720/60Hz, 1024 × 768/60Hz	VGA: 1-ch, 1920 × 1080/60Hz, 1280 × 1024/60Hz, 1280 × 720/60Hz, 1024 × 768/60Hz HDMI: 1-ch, 4K (3840 × 2160)/30Hz, 2K (2560 × 1440)/60Hz, 1920 × 1080/60Hz, 1280 × 1024/60Hz, 1280 × 720/60Hz, 1024 × 768/60Hz	1-ch, 1920 × 1080/60Hz, 1280 × 1024/60Hz, 1280 × 720/60Hz, 1024 × 768/60Hz
CVBS output		1-ch, BNC (1.0 Vp-p, 75 Ω), resolution: PAL: 704 × 576, NTSC: 704 × 480	1-ch, BNC (1.0 Vp-p, 75 Ω), resolution: PAL: 704 × 576, NTSC: 704 × 480
Encoding resolution	When 1080p Lite mode not enabled: 720p/WD1/4CIF/VGA/CIF When 1080p Lite mode enabled: 1080p lite/720p/WD1/4CIF/VGA/CIF	When 1080p Lite mode not enabled: 4 MP lite/3 MP/1080p/720p/VGA/WD1/4CIF/CIF; When 1080p Lite mode enabled: 4 MP lite/3 MP/1080p lite/720p lite/VGA/WD1/4CIF/CIF	When 1080p Lite mode not enabled: 4 MP lite/3 MP/1080p/720p/VGA/WD1/4CIF/CIF; When 1080p Lite mode enabled: 4 MP lite/3 MP/1080p lite/720p lite/VGA/WD1/4CIF/CIF
Video bitrate	32 Kbps to 4 Mbps	32 Kbps to 6 Mbps	32 Kbps to 6 Mbps
Audio output	1-ch, RCA (Linear, 1 KΩ)	1-ch, RCA (Linear, 1 KΩ)	1-ch, RCA (Linear, 1 KΩ)
Audio bitrate	64 Kbps	64 Kbps	64 Kbps
Synchronous playback	4-ch	16-ch	4-ch
SATA	1 SATA interface	1 SATA interface	1 SATA interface
Capacity	Up to 6 TB capacity for each disk	Up to 8 TB capacity for each disk	Up to 8 TB capacity for each disk
Network interface	1, RJ45 10M/100M self-adaptive Ethernet interface	1, RJ45 10M/100M/1000M self-adaptive Ethernet interface	1, RJ45 10M/100M self-adaptive Ethernet interface
USB port	Rear panel: 2 × USB 2.0	Front panel: 1 × USB 2.0 Rear panel: 1 × USB 3.0	2 × USB 2.0
Alarm in/out			
Power supply	12 VDC	12 VDC	12 VDC
Working temperature	-10 °C to +55 °C (14 °F to 131 °F)	-10 °C to +55 °C (14 °F to 131 °F)	-10 °C to +55 °C (14 °F to 131 °F)
Working humidity	10% to 90%	10% to 90%	10% to 90%
Dimensions(W × D × H)	260 × 222 × 45 mm (10.2 × 8.7 × 1.8 inch)	315 × 242 × 45 mm (12.4 × 9.5 × 1.8 inch)	315 × 242 × 45 mm (12.4 × 9.5 × 1.8 inch)

www.magazijninrichtingshop.nl - info@magazijninrichtingshop.nl - tel. +31(0)20-3633683



NEW

Short Description	DS-7200HQHI-K1 SERIES TURBO HD DVR
Model	DS-7200HQHI-Kx/P
Video compression	H.265+/H.265/H.264+/H.264
Analog video input	4-ch
HD-TVI video input	4 MP, 3 MP, 1080p30, 1080p25, 720p60, 720p50, 720p30, 720p25
IP video input	1-ch(Up to 4 MP resolution)
Audio compression	G.711u
Audio input	1-ch, RCA (2.0 Vp-p, 1 K Ω)
Two-way audio in	1-ch, RCA (2.0 Vp-p, 1 K Ω) (using the 1st audio input)
HDMI/VGA output	1-ch, 1920 x 1080/60Hz, 1280 x 1024/60Hz, 1280 x 720/60Hz, 1024 x 768/60Hz
CVBS output	1-ch, BNC (1.0 Vp-p, 75 Ω), resolution: PAL: 704 x 576, NTSC: 704 x 480
Encoding resolution	When 1080p Lite mode not enabled: 4 MP lite/3 MP/1080p/720p/VGA/WD1/4CIF/CIF; When 1080p Lite mode enabled: 4 MP lite/3 MP/1080p lite/720p lite/VGA/WD1/4CIF/CIF
Video bitrate	32 Kbps to 6 Mbps
Audio output	1-ch, RCA (Linear, 1 K Ω)
Audio bitrate	64 Kbps
Synchronous playback	4-ch
SATA	1 SATA interface
Capacity	Up to 8 TB capacity for each disk
Network interface	1, RJ45 10M/100M self-adaptive Ethernet interface
USB port	2 x USB 2.0
Alarm in/out	
Power supply	48 VDC
Working temperature	-10 °C to +55 °C (14 °F to 131 °F)
Working humidity	10% to 90%
Dimensions(W x D x H)	315 x 242 x 45 mm (12.4 x 9.5 x 1.8 inch)

www.magazijninrichtingshop.nl - info@magazijninrichtingshop.nl - tel. +31(0)26-3633683

1U CHASSIS



Short Description	DS-7204HTHI-K1 SERIES TURBO HD DVR	DS-7200HUHI-K1 SERIES TURBO HD DVR	DS-7200HUHI-K/P SERIES TURBO HD DVR
Model	DS-7200HTHI-Kx	DS-7200HUHI-Kx	DS-7200HUHI-Kx/P
Video compression	H.265+/H.265/H.264+/H.264	H.265+/H.265/H.264+/H.264	H.265+/H.265/H.264+/H.264
Analog video input	4-ch	4-ch	1-ch
HD-TVI video input	8 MP, 5 MP, 4 MP, 3 MP, 1080p30, 1080p25, 720p60, 720p50, 720p30, 720p25	5 MP, 4 MP, 3 MP, 1080p30, 1080p25, 720p60, 720p50, 720p30, 720p25	5 MP, 4 MP, 3 MP, 1080p30, 1080p25, 720p60, 720p50, 720p30, 720p25
IP video input	2-ch, Up to 8 MP resolution, Supports H.265+/H.265/H.264+/H.264 IP cameras	2-ch (Up to 6 MP resolution)	2-ch, Up to 6 MP resolution, Supports H.265+/H.265/H.264+/H.264 IP cameras
Audio compression	G.711u	G.711u	G.711u
Audio input	4-ch, RCA (2.0 Vp-p, 1 K Ω)	4-ch, RCA (2.0 Vp-p, 1 K Ω)	4-ch, RCA (2.0 Vp-p, 1 K Ω)
Two-way audio in	1-ch, RCA (2.0 Vp-p, 1 K Ω) (using the first audio input)	1-ch, RCA (2.0 Vp-p, 1 K Ω) (using the 1st audio input)	1-ch, RCA (2.0 Vp-p, 1 K Ω) (using the first audio input)
HDMI/VGA output	VGA: 1-ch, 1920 × 1080/60Hz, 1280 × 1024/60Hz, 1280 × 720/60Hz, 1024 × 768/60Hz HDMI: 1-ch, 4K (3840 × 2160)/30Hz, 2K (2560 × 1440)/60Hz, 1920 × 1080/60Hz, 1280 × 1024/60Hz, 1280 × 720/60Hz, 1024 × 768/60Hz	1-ch, 1920 × 1080/60Hz, 1280 × 1024/60Hz, 1280 × 720/60Hz, 1024 × 768/60Hz	1-ch, 1920 × 1080/60Hz, 1280 × 1024/60Hz, 1280 × 720/60Hz, 1024 × 768/60Hz
CVBS output	1-ch, BNC (1.0 Vp-p, 75 Ω), resolution: PAL: 704 × 576, NTSC: 704 × 480	1-ch, BNC (1.0 Vp-p, 75 Ω), resolution: PAL: 704 × 576, NTSC: 704 × 480	1-ch, BNC (1.0 Vp-p, 75 Ω), resolution: PAL: 704 × 576, NTSC: 704 × 480
Encoding resolution	8 MP/5 MP/4 MP/3 MP/1080p/720p/WD1/4CIF/VGA/CIF	5 MP/4 MP/3 MP/1080p/720p/WD1/4CIF/VGA/CIF	5 MP/4 MP/3 MP/1080p/720p/WD1/4CIF/VGA/CIF
Video bitrate	32 Kbps to 16 Mbps	32 Kbps to 10 Mbps	32 Kbps to 10 Mbps
Audio output	1-ch, RCA (Linear, 1 K Ω)	1-ch, RCA (Linear, 1 K Ω)	1-ch, RCA (Linear, 1 K Ω)
Audio bitrate	64 Kbps	64 Kbps	64 Kbps
Synchronous playback	4-ch	4-ch	4-ch
SATA	1 SATA interface	1 SATA interface	1 SATA interface
Capacity	Up to 8 TB capacity for each disk	Up to 8 TB capacity for each disk	Up to 8 TB capacity for each disk
Network interface	1, RJ45 10M/100M/1000M self-adaptive Ethernet interface	1, RJ45 10M/100M self-adaptive Ethernet interface	1, RJ45 10M/100M self-adaptive Ethernet interface
USB port	Front panel: 1 × USB 2.0 Rear panel: 1 × USB 3.0	2 × USB 2.0	2 × USB 2.0
Alarm in/out	4/1	4/1	4/1
Power supply	12 VDC	12 VDC	48 VDC
Working temperature	-10 °C to +55 °C (+14 °F to +131 °F)	-10 °C to +55 °C (14 °F to 131 °F)	-10 °C to +55 °C (+14 °F to +131 °F)
Working humidity	10% to 90%	10% to 90%	10% to 90%
Dimensions(W × D × H)	315 × 242 × 45 mm (12.4 × 9.5 × 1.8 inch)	315 × 242 × 45 mm (12.4 × 9.5 × 1.8 inch)	315 × 242 × 45 mm (12.4 × 9.5 × 1.8 inch)

www.magazijninrichtingshop.nl - info@magazijninrichtingshop.nl - tel: +31(0)20-3633683

1.5U CHASSIS



Short Description	DS-7324HQHI-K4 SERIES TURBO HD DVR	DS-7300HQHI-K SERIES TURBO HD DVR	DS-7324HQHI-K4 SERIES TURBO HD DVR
Model	DS-7300HQHI-K4	DS-7300HQHI-Kx	DS-7300HQHI-K4
Video compression	H.265+/H.265/H.264+/H.264	H.265+/H.265/H.264+/H.264	H.265+/H.265/H.264+/H.264
Analog video input	24-ch	16-ch	24-ch
HD-TVI video input	4 MP, 3 MP, 1080p25, 1080p30, 720p25, 720p30, 720p50, 720p60 Note: The 3 MP signal input is only available for channel 1/2/3/4.	4 MP, 3 MP, 1080p30, 1080p25, 720p60, 720p50, 720p30, 720p25	5 MP, 4 MP, 3 MP, 1080p25, 1080p30, 720p25, 720p30, 720p50, 720p60
IP video input	8-ch (up to 32-ch), Up to 6 MP resolution, Supports H.265+/H.265/H.264+/H.264 IP cameras	2-ch (up to 18-ch), Up to 4 MP resolution, Supports H.265+/H.265/H.264+/H.264 IP cameras	8-ch (up to 32-ch), Up to 8 MP resolution, Supports H.265+/H.265/H.264+/H.264 IP cameras
Audio compression	G.711u	G.711u	G.711u
Audio input	4-ch, RCA (2.0 Vp-p, 1 KΩ)	4-ch, RCA (2.0 Vp-p, 1 KΩ)	4-ch, RCA (2.0 Vp-p, 1 KΩ)
Two-way audio in	1-ch, RCA (2.0 Vp-p, 1 KΩ) (independent)	1-ch, RCA (2.0 Vp-p, 1 KΩ)	1-ch, RCA (2.0 Vp-p, 1 KΩ) (independent)
HDMI/VGA output	1-ch, 1920 × 1080/60Hz, 1280 × 1024/60Hz, 1280 × 720/60Hz, 1024 × 768/60Hz	HDMI: 1-ch, 4K (3840 × 2160)/30Hz, 2K (2560 × 1440)/60Hz, 1920 × 1080/60Hz, 1280 × 1024/60Hz, 1280 × 720/60Hz, 1024 × 768/60Hz VGA: 1-ch, 1920 × 1080/60Hz, 1280 × 1024/60Hz, 1280 × 720/60Hz, 1024 × 768/60Hz	1-ch, 1920 × 1080/60Hz, 1280 × 1024/60Hz, 1280 × 720/60Hz, 1024 × 768/60Hz
CVBS output	1-ch, BNC (1.0 Vp-p, 75 Ω), resolution: PAL: 704 × 576, NTSC: 704 × 480	1-ch, BNC (1.0 Vp-p, 75 Ω), resolution: PAL: 704 × 576, NTSC: 704 × 480	1-ch, BNC (1.0 Vp-p, 75 Ω), resolution: PAL: 704 × 576, NTSC: 704 × 480
Encoding resolution	When 1080p Lite mode not enabled: 4 MP lite/3 MP/1080p/1080p lite/720p/WD1/4CIF/VGA/CIF When 1080p Lite mode enabled: 4 MP lite/3 MP/1080p lite/720p/720p lite/WD1/4CIF/VGA/CIF	When 1080p Lite mode not enabled: 4 MP lite/3 MP/1080p/720p/VGA/WD1/4CIF/CIF; When 1080p Lite mode enabled: 4 MP lite/3 MP/1080p lite/720p lite/VGA/WD1/4CIF/CIF	5 MP/4 MP/3 MP/1080p/720p/WD1/4CIF/VGA/CIF
Video bitrate	32 Kbps to 6 Mbps	32 Kbps to 6 Mbps	32 Kbps to 10 Mbps
Audio output	1-ch, RCA (Linear, 1 KΩ)	2-ch, RCA (Linear, 1 KΩ)	1-ch, RCA (Linear, 1 KΩ)
Audio bitrate	64 Kbps	64 Kbps	64 Kbps
Synchronous playback	16-ch	16-ch	16-ch
SATA	4 SATA interfaces	4 SATA interfaces	4 SATA interfaces
Capacity	Up to 8 TB capacity for each disk	Up to 8 TB capacity for each disk	Up to 8 TB capacity for each disk
Network interface	1, RJ45 10M/100M/1000M self-adaptive Ethernet interface	1, RJ45 10M/100M/1000M self-adaptive Ethernet interface	2, RJ45 10M/100M/1000M self-adaptive Ethernet interface
USB port	Front panel: 2 × USB 2.0 Rear panel: 1 × USB 3.0	Front panel: 2 × USB 2.0 Rear panel: 1 × USB 3.0	Front panel: 2 × USB 2.0 Rear panel: 1 × USB 3.0
Alarm in/out	16/4	16/4	16/4
Power supply		100 to 240 VAC	100 to 240 VAC
Working temperature	-10 °C to +55 °C (+14 °F to +131 °F)	-10 °C to +55 °C (+14 °F to +131 °F)	-10 °C to +55 °C (+14 °F to +131 °F)
Working humidity	10% to 90%	10% to 90%	10% to 90%
Dimensions(W × D × H)	440 × 390 × 70 mm (17.3 × 15.4 × 2.8 inch)	445 × 390 × 70 mm (17.5 × 15.4 × 2.8 inch)	440 × 390 × 70 mm (17.3 × 15.4 × 2.8 inch)

www.magazijnrichtingshop.nl - tel. +31(0)20-3611683



NEW

Short Description	DS-7300HUHI-K4 SERIES TURBO HD DVR
Model	DS-7300HUHI-Kx
Video compression	H.265+/H.265/H.264+/H.264
Analog video input	8-ch
HD-TVI video input	5 MP, 4 MP, 3 MP, 1080p25, 1080p30, 720p25, 720p30, 720p50, 720p60
IP video input	2-ch (up to 10-ch), Up to 8 MP resolution, Supports H.265+/H.265/H.264+/H.264 IP cameras
Audio compression	G.711u
Audio input	4-ch, RCA (2.0 Vp-p, 1 K Ω)
Two-way audio in	1-ch, RCA (2.0 Vp-p, 1 K Ω)
HDMI/VGA output	1-ch, 1920 x 1080/60Hz, 1280 x 1024/60Hz, 1280 x 720/60Hz, 1024 x 768/60Hz
CVBS output	1-ch, BNC (1.0 Vp-p, 75 Ω), resolution: PAL: 704 x 576, NTSC: 704 x 480
Encoding resolution	5 MP/4 MP/3 MP/1080p/720p/WD1/4CIF/VGA/CIF
Video bitrate	32 Kbps to 10 Mbps
Audio output	2-ch, RCA (Linear, 1 K Ω)
Audio bitrate	64 Kbps
Synchronous playback	8-ch
SATA	4 SATA interfaces
Capacity	Up to 8 TB capacity for each disk
Network interface	2, RJ45 10M/100M/1000M self-adaptive Ethernet interface
USB port	Front panel: 2 x USB 2.0 Rear panel: 1 x USB 3.0
Alarm in/out	16/4
Power supply	100 to 240 VAC
Working temperature	-10 °C to +55 °C (+14 °F to +131 °F)
Working humidity	10% to 90%
Dimensions(W x D x H)	445 x 390 x 70 mm (17.5 x 15.4 x 2.8 inch)

www.magazijninrichtingshop.nl - info@magazijninrichtingshop.nl - tel. +31(0)26-3633683



MONITORS

Hikvision also offers a selection of monitors to complement your security solution. Whatever size you need - from 19" to 84", our LED displays give you eyes on your security solution.

SWITCHES

Hikvision also offers a range of professional switches to maximise the effect of your solution by extending your reach and increasing your data capacity.

DE-/ENCODERS

There are a number of Decoder and Encoder products to choose from to complement your solution.

KEYBOARDS & ACCESSORIES

To further enhance any surveillance system, Hikvision provides a comprehensive set of keyboards & accessories; video balun, coaxial transmission, PoE video repeaters, microphone, HDD and brackets.

www.magazijninrichtingshop.nl - tel. +31(0)26-3633683
info@magazijninrichtingshop.nl

18.5"



21.5"



23.6"



NEW

Short Description	18.5" Monitor	21.5" LED Monitor	21.5" LED Monitor	23.6" LED Monitor
Model	DS-D50190E-B	DS-D5022FC	DS-D50220E-B	DS-D5024FC
Display Type	LED-Backlit TFT LCD	LED-Backlit	LED-Backlit	LED-Backlit
Resolution	1366 x 768	1920 x 1080	1920 x 1080	1920 x 1080
Contrast	600:1	1000:1	1000:1	1000:1(Typical) DCR 30,000,000:1
Response Time	5ms	5ms	5ms	5ms
VESA	75 mm x 75 mm	100mm x 100mm	100mm x 100mm	100mm x 100mm
Power Supply	100 to 240 VAC, 50/60Hz	DC 12V/3.0A	100 ~ 240V AC	AC 100~240V
Power Consumption	< 25 W(on) < 0.5 W(Standby)	< 30W(on) < 0.5W(Standby)	< 30W(on) < 0.4W(Standby)	< 30W(on) < 0.5W(Standby)
Operation Temperature	0°C ~ 40 °C	0°C ~ 40 °C	0°C ~ 40 °C	0°C ~ 40 °C
Dimension	445.58 mm x 274.99 mm x 44.6mm	511.4mm x 313.0mm x 45.4mm	511mm x 377mm x 170mm	561x339x218.5 (mm) 22.1x13.3x8.6(inch)
Frame Width/Height (T/B/L/R)				
Weight	3.5 Kg(Gross weight) , 2.8 Kg(Net weight)	4.6Kg(Gross weight) , 3.2(Net weight)	4.5Kg(Gross weight) , 3.3(Net weight)	6.0Kg(Gross weight) , 5.1(Net weight)

www.magazijninrichtingshop.nl - info@magazijninrichtingshop.nl - tel. +31(0)26-3633683

32"



32"



49"



Short Description	32" LED Monitor	32" Monitor	49" Monitor
Model	DS-D5032FC	DS-D5032FL	DS-D5049FL
Display Type	TFT-LED Backlight	LED-Backlit TFT LCD	LED-Backlit TFT LCD
Resolution	1920 × 1080	1920 × 1080	1920 × 1080
Contrast	3000:1	3000:1	1100 : 1
Response Time	6.5ms	6.5 ms	12 ms
VESA	200mm x 100mm	200 mm x 200 mm	
Power Supply	100 ~ 240V AC, 50/60Hz	100 to 240 VAC, 50/60Hz	100 to 240 VAC, 50/60Hz
Power Consumption	≤ 55W	< 60W(on) < 1W(Standby)	< 60W(on) < 1W(Standby)
Operation Temperature	5°C ~ 40°C	0°C ~ 40 °C	0°C ~ 40 °C
Dimension	743.95mm × 443.40mm × 58.70mm	737.4 mm × 452.5 mm × 70.65 mm (29.03" x 17.81" x 2.78")	1141.18 mm × 677.5 mm × 69 mm
Frame Width/Height (T/B/L/R)			
Weight	10.6Kg(Gross weight) , 8Kg(Net weight)	19 Kg(Gross weight) ,12 Kg (Net weight)	32 Kg(Gross weight) , 24.65 Kg(Net weight)

www.magazijninrichtingshop.nl - info@magazijninrichtingshop.nl - tel. +31(0)26-3633683

55"



NEW

Short Description	55" Ultra HD Display
Model	DS-D5055UL-B
Display Type	LCD Backlight
Resolution	3840 × 2160
Contrast	1100:1
Response Time	8 ms
VESA	
Power Supply	100 to 240 VAC, 50/60Hz
Power Consumption	≤ 100 W
Operation Temperature	0 to 40 °C (0 to 104 °F)
Dimension	
Frame Width/Height (T/B/L/R)	
Weight	≤ 41 kg (90.4 lb)(Gross weight), ≤ 35 kg (77.2 lb)(Net weight)

www.magazijninrichtingshop.nl - info@magazijninrichtingshop.nl - tel. +31(0)26-3633683

5 PORTS



8 PORTS



NEW

9 PORTS



NEW

Short Description	4-ports 100Mbps Unmanaged PoE Switch	DS-3E Series Unmanaged PoE Switch	8-ports 100Mbps Unmanaged PoE Switch	DS-3E Series Unmanaged PoE Switch
Model	DS-3E0105P-E	DS-3E0108P-E	DS-3E0109P-E	DS-3E0109P-E/M
Network Ports	5	8	9	9
Switching Capacity	16Gbps	1.6 Gbps	1.8Gbps	1.8 Gbps
Max. Forwarding Rate	0.74Mpps		1.34Mpps	
High Priority Ports	Port 1		Ports 1-2	Port 1 - 2
Flow Control	IEEE802.3x full duplex		IEEE802.3x full duplex	
PoE Standard	IEEE802.3af, IEEE802.3at	IEEE 802.3af, IEEE802.3at	IEEE802.3af, IEEE802.3at	IEEE 802.3af, IEEE802.3at
PoE Power Budget	58W		123W	58 W
Working Mode	Extend On:250m,10M,CAT 5eExtend Off:100m		Extend On:250m,10M,CAT 5eExtend Off:100m	EXTEND OFF, EXTEND ON
Power Supply	51V DC, 1.25A	51 V DC, 1.25 A	51 V DC, 2.5A	51 V DC
Working Temperature	00-400	0 °C ~ 40 °C	00-400	0 °C ~ 40 °C

www.magazijninrichtingshop.nl - info@magazijninrichtingshop.nl - tel. +31(0)26-3653683

18 PORTS



26 PORTS



Short Description	16-ports 100Mbps Unmanaged PoE Switch	DS-3E Series Unmanaged PoE Switch	24-ports 100Mbps Unmanaged PoE Switch	DS-3E Series Unmanaged PoE Switch
Model	DS-3E0318P-E	DS-3E0318P-E/M	DS-3E0326P-E	DS-3E0326P-E/M
Network Ports	18	18	26	26
Switching Capacity	7.2Gbps	7.2 Gbps	8.8Gbps	8.8 Gbps
Max. Forwarding Rate	5.36Mpps		6.55Mpps	
High Priority Ports	Ports 1-8	Port 1 - 8	Ports 1-8	Port 1 - 8
Flow Control	IEEE802.3x full duplex		IEEE802.3x full duplex	
PoE Standard	IEEE802.3af,IEEE802.3at	IEEE 802.3af, IEEE802.3at	IEEE802.3af, IEEE802.3at	IEEE 802.3af, IEEE802.3at
PoE Power Budget	230W	135 W	370W	225 W
Working Mode	Extend On:250m,10M,CAT 5e Extend Off:100m	Priority, Standard, Isolate, Extend	Extend On:250m,10M,CAT 5e Extend Off:100m	
Power Supply	100-240V AC, 50/60Hz	100-240 V AC, 50/60 Hz	100-240V AC, 50/60Hz	100-240 V AC, 50/60 Hz
Working Temperature	00-400	0 °C - 40 °C	00-400	0 °C - 40 °C

www.magazijninrichtingshop.nl - info@magazijninrichtingshop.nl - tel. +31(0)26-3613683

10 PORTS



18 PORTS



26 PORTS



Short Description

Web-managed PoE switch with 8 100M PoE electrical ports and 2 1000M COMBO ports

Web-managed PoE switch with 16 100M PoE electrical ports and 2 1000M COMBO ports

Web-managed PoE switch with 24 100M PoE electrical ports and 2 1000M COMBO ports

Model	DS-3E1310P-E	DS-3E1318P-E	DS-3E1326P-E
Network Ports	10	18	26
Switching Capacity	802.3x, IEEE802.3z	802.3x, IEEE802.3z	8.8 Gbps
Max. Forwarding Rate			
High Priority Ports	Port 1 to 8	Port 1 to 8	Port 1 - 8
Flow Control			
PoE Standard	IEEE 802.3af, IEEE802.3at	IEEE 802.3af, IEEE802.3at	IEEE 802.3af, IEEE802.3at
PoE Power Budget	123W	230W	370W
Working Mode	Extend On:250m,10M,CAT 5eExtend Off:100m	Extend On:250m,10M,CAT 5e Extend Off:100m	
Power Supply	100-240V AC, 50/60Hz	100-240V AC, 50/60Hz	100 to 240 VAC, 50/60Hz
Working Temperature	00-400	00-400	0 °C to +40 °C (+32 °F to +104 °F)

www.magazijninrichtingshop.nl - info@magazijninrichtingshop.nl - tel. +31(0)26-3633683

8 PORTS



NEW

16 PORTS



NEW

24 PORTS



NEW

Short Description	DS-3E05-E Series Unmanaged Gigabit Switch	DS-3E05-E Series Unmanaged Gigabit Switch	DS-3E05-E Series Unmanaged Gigabit Switch
Model	DS-3E0508-E	DS-3E0516-E	DS-3E0524-E
Network Ports	8	16	24
Switching Capacity			
Max. Forwarding Rate	Ethernet: 14881 pps one portFast Ethernet: 148810 pps one portGigabit Ethernet: 1488100 pps one port	Ethernet: 14881 pps one portFast Ethernet: 148810 pps one portGigabit Ethernet: 1488100 pps one port	Ethernet: 14881 pps one portFast Ethernet: 148810 pps one portGigabit Ethernet: 1488100 pps one port
High Priority Ports			
Flow Control			
PoE Standard			
PoE Power Budget			
Working Mode			
Power Supply	Input: 100-240 V AC, 50/60 Hz, 0.3 AOutput: 9 V DC, 1 A	Input: 100-240 V AC, 50/60 Hz	Input: 100-240 V AC, 50/60 Hz
Working Temperature	0°C - 40°C	0°C - 40°C	0°C - 40°C

www.magazijninrichtingshop.nl - info@magazijninrichtingshop.nl - tel. +31(0)26-3633683



Short Description	DS-6400HDI-T Series Decoder
Model	DS-6400HDI-T
HDMI Output	
VGA Output	
BNC Output	
Decoding Resolution	8MP
Decoding Channel	8MP: 2-ch 5MP: 4-ch 1080p: 8-ch 720p: 16-ch 4CIF: 32-ch
Decoding Capability	8MP: 2-ch 5MP: 4-ch 1080p: 8-ch 720p: 16-ch 4CIF: 32-ch
Split Screen	1/4/9/16
Network Interface	1; 10/100/1000 Mbps self-adaptive Ethernet interface
Serial Interface	1 RS-232 (DB9), 1 RS-485
Two-Way Audio In	1-ch, 3.5 mm connector (2.0 Vp-p, 1 kΩ)
Two-Way Audio Out	1-ch, 3.5 mm connector (2.0 Vp-p, 1 kΩ)
Audio Output	8-ch, DB15 connector
Alarm In	4-ch
Alarm Out	4-ch
Power Supply	100 to 240 VAC
Power Consumption	≤ 108 W
Working Temperature	-10° C to 55° C (14° F to 131° F)
Working Humidity	10% to 90%

www.magazijninrichtingshop.nl - info@magazijninrichtingshop.nl - tel. +31(0)26-3633683



Short Description	DS-6900UDI SERIES DECODER
Model	DS-6900UDI
HDMI Output	4K: 3840 × 2160@30Hz (for even interface only) 1080p: 1920 × 1080@50/60Hz WSXGA: 1680×1050/60Hz UXGA: 1600 × 1200@60Hz (for even interface only) 720p: 1280 × 720@50Hz/60Hz SXGA: 1280 × 1024@60Hz XGA: 1024 × 768@60Hz
VGA Output	1080p: 1920 × 1080@50/60Hz WSXGA: 1680×1050/60Hz SXGA: 1280 × 1024@60Hz 720p: 1280 × 720@50Hz/60Hz XGA: 1024 × 768@60Hz
BNC Output	1-ch
Decoding Resolution	12MP
Decoding Channel	16-ch
Decoding Capability	12MP@20fps: 2-ch 8MP@30fps: 4-ch 5MP@30fps: 6-ch 3MP@30fps: 10-ch 1080p@30fps: 16-ch
Split Screen	1/4/6/8/9/12/16
Network Interface	1, 10/100/1000 Mbps self-adaptive Ethernet interface
Serial Interface	1 RS-232 (RJ45), 1 RS-485
Two-Way Audio In	1-ch, 3.5 mm connector (2.0 Vp-p, 1 KΩ)
Two-Way Audio Out	1-ch, 3.5 mm connector (2.0 Vp-p, 1 KΩ)
Audio Output	1-ch
Alarm In	8-ch
Alarm Out	8-ch
Power Supply	12 VDC
Power Consumption	≤ 15 W
Working Temperature	-10 °C to +55 °C (14 °F to 131 °F)
Working Humidity	10% to 90%

www.magazijninrichtingshop.nl - info@magazijninrichtingshop.nl - tel. +31(0)26-3633683



Short Description	DS-6700HQHI-SATA Series Encoder
Model	DS-6700HQHI-SATA
Video compression	H.264
Analog video input	8-ch
Audio input	4-ch, RCA (2.0 Vp-p, 1 K Ω)
Two-way audio in	1-ch, RCA (2.0 Vp-p, 1 K Ω)(using the 1st channel of audio input)
HDMI/VGA output	
HDMI2 output	
Encoding resolution	
Video bitrate	32 Kbps to 10 Mbps
Audio output	1-ch, RCA (Linear, 1 K Ω)
Audio bitrate	64 Kbps
SATA	1 SATA interface
Capacity	Up to 6 TB capacity for each disk
Network interface	1, RJ45 10M/100M self-adaptive Ethernet interface
Serial interface	1, RS-485; half-duplex
Alarm in/out	8/4
Power supply	12 VDC
Consumption(without hard disks)	\leq 30 W
Working temperature	-10 °C to +55 °C (14 °F to 131 °F)
Working humidity	10% to 90%
Chassis	380 mm 1U chassis

www.magazijninrichtingshop.nl - info@magazijninrichtingshop.nl - tel. +31(0)26-3633683



Short Description	DS-1005KI USB Keyboard	DS-1100KI Network Keyboard	DS-1200KI Series Network Keyboard	DS-1600KI Network Keyboard
Model	DS-1005KI	DS-1100KI	DS-1200KI	DS-1600KI
LCD screen		800 x 480 pixel screen	128 x 64 pixel screen	Resolution: 1024 x 600
Joystick	3-axis joystick	4-axis joystick	4-axis joystick	4-axis joystick
Control mode		IP-based	Network, RS-232, RS-422, RS-485	
Network interface		1; 10M/100M/1000M Ethernet interface	1; 10 M/100 Mbps self-adaptive Ethernet interface	10M/100M/1000M Adaptive Ethernet port
Serial interface		1 RS-232, 1 RS-485	1 RS-232, 1 RS-422, 1 RS-485	
USB interface	USB 2.0	USB 2.0	USB 2.0	USB 2.0 x 2
Power supply	5V DC via USB	12V DC	12V DC	12V DC / POE
Consumption	≤ 5W	≤ 15W	≤ 4.5 W	≤ 15W
Working temperature	-10 °C-55 °C (14 °F-131 °F)	-10 °C-55 °C (14 °F-131 °F)	-10 °C-55 °C (14 °F-131 °F)	-10°C -- +55°C
Working humidity	10%-90%	10%-90%	10%-90%	10%-90%
Dimensions (W x D x H)	167 x 177.5 x 116 mm (6.57 x 6.99 x 4.57 inch)	435 x 193 x 110 mm (17.1 x 7.6 x 4.3 inch)	435 x 193 x 110 mm (17.1 x 7.6 x 4.3 inch)	404 x 180 x 163 mm
Weight		2 Kg (4.4 lb)	≤ 1 kg (2.2 lb)	1.7 Kg

www.magazijninrichtingshop.nl - info@magazijninrichtingshop.nl - tel. +31(0)26-3633683



Short Description	DS-1004KI RS-485 Keyboard	DS-1006KI Series Keyboard
Model	DS-1004KI	DS-1006KI
LCD screen		128 x 64 pixel screen
Joystick	4-axis joystick	4-axis joystick
Control mode	RS-485 and RS-232	RS-232, RS-422, RS-485
Network interface		
Serial interface	1 RS-485 and 1 RS-232	1 RS-232, 1 RS-422, 1 RS-485
USB interface		USB 2.0
Power supply	12V DC	12V DC
Consumption	≤10W	≤ 4.5 W
Working temperature	-10 °C-55 °C (14 °F-131 °F)	-10 °C-55 °C (14 °F-131 °F)
Working humidity	10%-90%	10%-90%
Dimensions (W × D × H)	434 × 163 × 43 mm (17.09 × 6.42 × 1.69 inch)	435 × 193 × 110 mm (17.1 × 7.6 × 4.3 inch)
Weight	≤1.25Kg (2.76lb)	≤ 1 kg (2.2 lb)

www.magazijninrichtingshop.nl - info@magazijninrichtingshop.nl - tel. +31(0)26-3633683



www.magazijninrichtingshop.nl - info@magazijninrichtingshop.nl - tel +31(0)26-3633683

DS-1LN5E-S
U/UTP 4Pairs cable-category 5E-
PVC Sheath



DS-1LN6-UU
U/UTP 4Pairs cable-category 6-
PVC Sheath



www.magazijninrichtingshop.nl - info@magazijninrichtingshop.nl - tel. +31(0)26-3633683



www.magazijninrichtingshop.nl - tel: +31(0)26-3633683
info@magazijninrichtingshop.nl



www.magazijninrichtingshop.nl - info@magazijninrichtingshop.nl - tel. (0)26 3633683



www.magazijninrichtingshop.nl - info@magazijninrichtingshop.nl - tel. +31(0)26-3633683



www.magazijninrichtingshop.nl - info@magazijninrichtingshop.nl - tel. +31(0)26-3633683

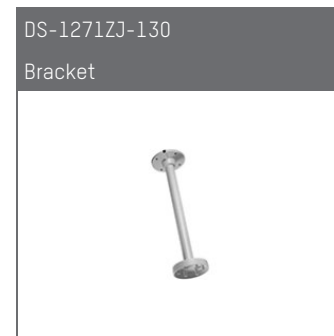
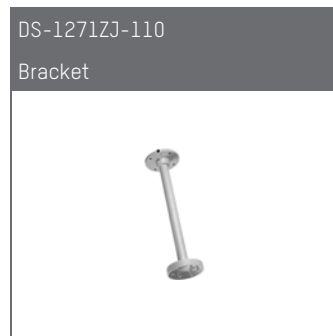
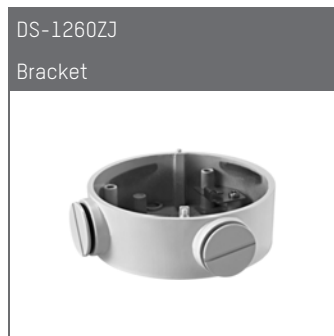
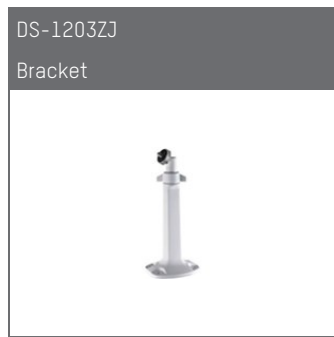

www.magazijninrichtingshop.nl - info@magazijninrichtingshop.nl - tel. +31(0)26-3633683



www.magazijninrichtingshop.nl - info@magazijninrichtingshop.nl - tel. +31(0)26-3633683

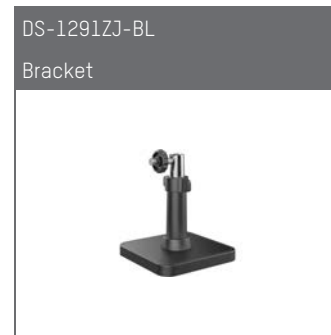
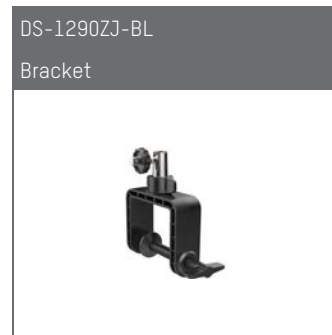

www.magazijninrichtingshop.nl - info@magazijninrichtingshop.nl - tel. +31(0)26-3633683

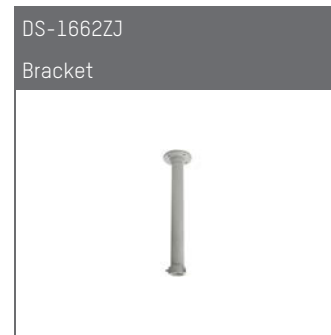
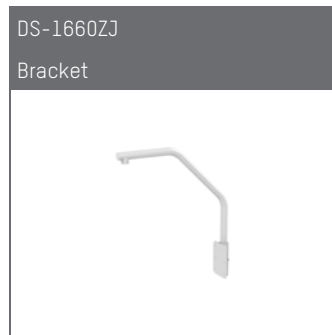

www.magazijnrichtingshop.nl - info@magazijnrichtingshop.nl - tel. +31(0)26-3633683

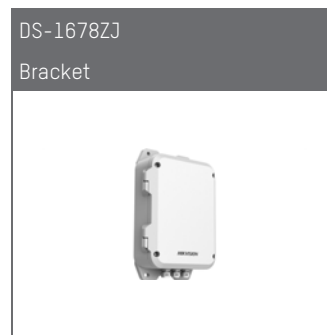



www.magazijninrichtingshop.nl - info@magazijninrichtingshop.nl - tel. +31(0)26-3633683

BRACKET

ANALOGUE CAMERA





Product form	Model	Relevant brackets and housings					
		Indoor			Indoor housing		Outdoor housing
Box camera 18	DS-2CC12D9T-A DS-2CC12D9T-E						
		DS-1299ZJ	DS-1280ZJ-XS	DS-1292ZJ	DS-1332HZ	DS-1330HZ	DS-1331HZ Series
		Pendant Mount	Junction box	Wall mount	Indoor housing	Indoor housing	Outdoor housing
		Hik white Aluminum Alloy 77×77×198mm 165g	Hik white Aluminum Alloy Φ100 x 43.2 x 129mm 320g (Match up with DS-1299ZJ)	Hik white Aluminum alloy 70×97.1×217.9mm 201g	Hik white Aluminum alloy 288×149×100mm 800g	Hik white Complex fiber 290×142×92mm 640g	Hik white Aluminum alloy



Product form	Model	Relevant brackets and housings	
		Indoor/Outdoor	
Bullet camera 14	DS-2CE16D0T-IR(P)		
		DS-1280ZJ-XS	
		Junction box	
		Hik white Aluminum Alloy Φ100 x 43.2 x 129mm 320g	

Product form	Model	Relevant brackets and housings	
		Indoor/Outdoor	
Bullet camera 15	DS-2CE16D5T-IT1/IT3		
		DS-1280ZJ-XS	
		Junction box	
		Hik white Aluminum Alloy Φ100 x 43.2 x 129mm 320g	





Product form	Model	Relevant brackets and housings			
		Indoor/Outdoor			
Bullet camera 16	DS-16CE2D5T-IT5				
		DS-1275Z-SUS	DS-1260ZJ	DS-1280ZJ-S	DS-1276ZJ-SUS
		Vertical pole mount	Junction box	Junction box	Corner mount
		Hik white Stainless Steel 127×46×250mm Diameter of clamp: Φ67-127mm 1205g	Hik white Aluminum alloy Φ105 mm	Hik white Aluminum alloy Φ137 x 53.4x 164.8mm 527g	Hik white Stainless Steel 126×105×250mm 2280g

www.magazijnrichtingshop.nl - info@magazijnrichtingshop.nl - tel. +31(0)26-3633683

Product form	Model	Relevant brackets and housings			
		Indoor/Outdoor			
Bullet camera 20	DS-2CE16D5T-(A)VFIT3				
		DS-1275Z-SUS	DS-1260ZJ	DS-1280ZJ-S	DS-1276ZJ-SUS
		Vertical pole mount	Junction box	Junction box	Corner mount
		Hik white Stainless Steel 127×46×250mm Diameter of clamp: Ø67-127mm 1205g	Hik white Aluminum alloy Ø105 mm	Hik white Aluminum alloy Ø137 x 53.4x 164.8mm 527g	Hik white Stainless Steel 126×105×250mm 2280g

Product form	Model	Relevant brackets and housings
		Indoor/Outdoor
Bullet camera 22 Bullet camera 23	DS-2CC12D9T-IT3E/IT5E DS-2CE16H1T-IT1/IT3/IT5 DS-2CE16D7T-IT1/IT3/IT5 DS-2CE16F7T-IT1/IT3/IT5 DS-2CE16F1T-IT1/IT3/IT5 DS-2CE16D0T-IT1/IT3/IT5	
		DS-1280ZJ-XS
		Junction box
		Hik white Aluminum Alloy Ø100 x 43.2 x 129mm 320g

Product form	Model	Relevant brackets and housings			
		Indoor/Outdoor			
Bullet camera 24	DS-2CE16D9T-AIRAZH				
		DS-1275Z-SUS	DS-1260ZJ	DS-1280ZJ-S	DS-1276ZJ-SUS
		Vertical pole mount	Junction box	Junction box	Corner mount
		Hik white Stainless Steel 127×46×250mm Diameter of clamp: Ø67-127mm 1205g	Hik white Aluminum alloy Ø105 mm	Hik white Aluminum alloy Ø137 x 53.4x 164.8mm 527g	Hik white Stainless Steel 126×105×250mm 2280g

Product form	Model	Relevant brackets and housings		
		Indoor/Outdoor		
Bullet camera 25	DS-2CE16D5T-AIR3ZH DS-2CE16D7T-(A)IT3Z DS-2CE16F7T-(A)IT3Z DS-2CE16H1T-(A)IT3Z DS-2CC12D9T-AIT3ZE			
		DS-1275Z-SUS	DS-1280ZJ-S	DS-1276ZJ-SUS
		Vertical pole mount	Junction box	Corner mount
		Hik white Stainless Steel 127×46×250mm Diameter of clamp: Ø67- 127mm 1205g	Hik white Aluminum alloy Ø137 x 53.4x 164.8mm 527g	Hik white Stainless Steel 126×105×250mm 2280g

Product form	Model	Relevant brackets and housings
		Indoor/Outdoor
Bullet camera 32	DS-2CE16D7T-IT DS-2CE16F7T-IT DS-2CE16F1T-IT DS-2CE16H1T-IT	
		DS-1280ZJ-XS
		Junction box
		Hik white Aluminum Alloy Ø100 x 43.2 x 129mm 320g





www.magazijninrichtingshop.nl - info@magazijninrichtingshop.nl - tel. +31(0)26-3633683

Product form		Model		Relevant brackets and housings							
Dome camera 11		DS-2CC52D9T-AVPIT3ZE DS-2CE56H1T-(A)VPIT3ZE DS-2CE56D7T-(A)VPIT3Z DS-2CE56F7T-(A)VPIT3Z DS-2CE56D5T-(A)VPIR3H DS-2CE56D5T-AVPIR3Z(H)		Indoor/Outdoor							
											
		DS-1271ZJ-140	DS-1273ZJ-140	DS-1273ZJ-140B	DS-1241ZJ	DS-1240ZJ	DS-1275ZJ-SUS	DS-1276ZJ-SUS	DS-1253ZJ-L	DS-1250ZJ	
		Pendant Mount	Wall mount	Wall mount	In-ceiling mount	Inclined ceiling mount	Vertical pole mount	Corner mount	Rain shade	Rain shade	
		Hik white Aluminum alloy Ø150×565mm 1900g	Hik white Aluminum alloy 140×183.5×232mm 703g	Hik white Aluminum alloy with junction box 140×243×292mm 1488g	Hik white Aluminum alloy Ø200×26.8mm 300g	Hik white Aluminum alloy Ø145×63mm 440g	Hik white Stainless Steel 127×46×250mm Diameter of clamp: Ø67-127mm 1205g Match up with wall mount(DS-1273ZJ-140)	Hik white Stainless Steel 126X105X250mm 2280g Match up with wall mount(DS-1273ZJ-140)	Hik white Composite Fibre Ø225.1×98mm 198g Match up with wall mount(DS-1273ZJ-140)	Hik white Composite Fibre 264.7*152*189.6 mm 199g	

Product form		Model		Relevant brackets and housings							
Dome camera 16		DS-2CC52D9T-AITZE DS-2CE56H1T-(A)ITZ DS-2CE56D7T-(A)ITZ DS-2CE56F7T-(A)ITZ DS-2CE56D5T-(A)VFI DS-2CE56D5T-AIRZ		Indoor							
											
		DS-1271ZJ-130	DS-1273ZJ-130	DS-1273ZJ-130B	DS-1249ZJ	DS-1275ZJ-SUS	DS-1276ZJ-SUS	DS-1253ZJ-L	DS-1250ZJ		
		Pendant Mount	Wall mount	Wall mount	In-ceiling mount	Vertical pole mount	Corner mount	Rain shade	Rain shade		
		Hik white Aluminum alloy Ø150×565mm 1900g	Hik white Aluminum alloy 132×183.5×228.5mm 690g	Hik white Aluminum alloy with junction box 132×243×288.5mm 1475g	Hik white ABS plastic Ø169.4×14.6mm 60g	Hik white Stainless Steel 127×46×250mm Diameter of clamp: Ø67-127mm 1205g Match up with wall mount(DS-1273ZJ-130)	Hik white Stainless Steel 126X105X250mm 2280g Match up with wall mount(DS-1273ZJ-130)	Hik white Composite Fibre Ø225.1×98mm 198g Match up with wall mount(DS-1273ZJ-130)	Hik white Composite Fibre 264.7*152*189.6 mm 199g		

Product form		Model		Relevant brackets and housings							
Dome camera 18		DS-2CE56H1T-VPIT DS-2CE56F1T-VPIT DS-2CE56D7T-VPIT DS-2CE56F7T-VPIT		Indoor							
											
		DS-1250ZJ	DS-1271ZJ-110	DS-1272ZJ-110	DS-1272ZJ-110B	DS-1275ZJ-SUS	DS-1276ZJ-SUS	DS-1280ZJ-DM18	DS-1258ZJ	DS-1253ZJ-M	DS-1250ZJ
		Inclined ceiling mount	Pendant mount	Wall mount	Wall mount	Vertical pole mount	Corner mount	Junction box	Wall mount	Rain shade	Rain shade
		Hik white ABS Plastic Ø111×39.2mm 200g	Hik white Aluminum alloy Ø150×560mm 1900g	Hik white Aluminum alloy 120×122×169mm 420g	Hik white Aluminum alloy with junction box 123×180×227.8mm 1205g	Hik white Stainless Steel 127×46×250mm Diameter of clamp: Ø67-127mm 1205g Match up with wall mount(DS-1272ZJ-110)	Hik white Stainless Steel 126X105X250mm 2280g Match up with wall mount(DS-1272ZJ-110)	Hik white Aluminum alloy Ø115.4×43.8mm 450g	Hik white ABS plastic 120×111×161.5mm 200g	Hik white Composite Fibre Ø191.1×76mm 133g Match up with wall mount(DS-127	Hik white Composite Fibre 264.7*152*189.6 mm 199g

www.magazijninrichtingshop.nl - info@magazijninrichtingshop.nl - tel: +31(0)26-3633683

Product form	Model	Relevant brackets and housings			
Fisheye	DS-2CC52H1T-FITS	Indoor			
					
	DS-1294ZJ	DS-1281ZJ-DM27	DS-1297ZJ	DS-1299ZJ	
	Wall mount	Inclined ceiling mount	Pendant mount (extendable)	Pendant Mount	
	Hik white Toughened Plastic 223.9×80×125.8mm 450g	Hik white Plastic 111.8×40.5×108.3mm 45.8g	Hik white Aluminum alloy (Height 1000-2000mm)	Hik white Aluminum Alloy 77×77×198mm 165g	





Product form / Model	Product form / Model	Relevant brackets and housings			
Mini dome camera3	Mini dome camera5	Indoor			
DS-2CE56H1T-ITM DS-2CE56D7I-ITM DS-2CE56F7I-ITM DS-2CE56F1I-ITM DS-2CE56D5T-IRM DS-2CE56D0T-IRM	DS-2CE56C0T-IR DS-2CE56C0T-IRP DS-2CE56D0T-IR(P)				
		DS-1272ZJ-110-TRS	DS-1275ZJ-SUS	DS-1276ZJ-SUS	DS-1280ZJ-XS
		Wall mount	Vertical pole mount	Corner mount	Junction box
		Hik white Aluminum alloy 120×122×169mm 420g	Hik white Stainless Steel 127×46×250mm Diameter of clamp: Ø67-127mm 1205g Match up with wall mount(DS-1272ZJ-110-TRS)	Hik white Stainless Steel 126×105×250mm 2280g Match up with wall mount(DS-1272ZJ-110-TRS)	Hik white Aluminum Alloy Ø100 x 43.2 x 129mm 320g

Product form	Model	Relevant brackets and housings					
Mini dome camera 9	DS-2CE56D5T-IT1/IT3	Indoor/Outdoor					
							
	DS-1272ZJ-110-TRS	DS-1275ZJ-SUS	DS-1276ZJ-SUS	DS-1258ZJ	DS-1280ZJ-S	DS-1281ZJ-S	DS-1271ZJ-110
	Wall mount	Vertical pole mount	Corner mount	Wall mount	Junction box	Inclined ceiling mount	Pendant mount
	Hik white Aluminum alloy 120×122×169mm 420g	Hik white Stainless Steel 127×46×250mm Diameter of clamp: Ø67-127mm 1205g Match up with wall mount(DS-1272ZJ-110)	Hik white Stainless Steel 126×105×250mm 2280g Match up with wall mount(DS-1272ZJ-110)	Hik white ABS plastic 120×111×161.5mm 200g Suitable for indoor	Hik white Aluminum alloy Ø137 x 53.4x 164.8mm 527g	Hik white Aluminum alloy 137×56.5×147mm 472g	Hik white Aluminum alloy Ø100×560mm 1900g

*Note: the -TRS means it has adapter plate compared to DS-1272ZJ-110. Special for these mini dome cameras

Product form	Model	Relevant brackets and housings				
Mini dome camera 10	DS-2CE56D5T-VFIT3	Indoor/Outdoor				
						
	DS-1273ZJ-130-TRL	DS-1275ZJ-SUS	DS-1276ZJ-SUS	DS-1280ZJ-M	DS-1281ZJ-M	DS-1271ZJ-130-TRL
	Wall mount	Vertical pole mount	Corner mount	Junction box	Inclined ceiling mount	Pendant mount
	Hik white Aluminum alloy 131×183.5×228.5mm 890g	Hik white Stainless Steel 127×46×250mm Diameter of clamp: Ø67-127mm 1205g Match up with wall mount(DS-1273ZJ-130-TRL)	Hik white Stainless Steel 126×105×250mm 2280g Match up with wall mount(DS-1273ZJ-130-TRL)	Hik white Aluminum alloy 157×184.8×53.4mm 621g	Hik white Aluminum alloy 157×165.7×61.8mm 586g	Hik white Aluminum alloy Ø150×567mm

www.magazijninrichtingshop.nl
tel. +31(0)26-3623683

Product form	Model	Relevant brackets and housings				
		Indoor/Outdoor				
Mini dome camera 12	DS-2CE56D5T-IR3Z DS-2CE56D7T-IT3Z DS-2CE56F7T-IT3Z DS-2CE56H1T-IT3Z					
	DS-1273ZJ-130-TRL	DS-1275ZJ-SUS	DS-1276ZJ-SUS	DS-1280ZJ-M	DS-1281ZJ-M	
	Wall mount	Vertical pole mount	Corner mount	Junction box	Inclined ceiling mount	
	Hik white Aluminum alloy 131×183.5×228.5mm 890g	Hik white Stainless Steel 127×46×250mm Diameter of clamp: Ø67-127mm 1205g Match up with wall mount(DS-1273ZJ-130-TRL)	Hik white Stainless Steel 126X105X250mm 2280g Match up with wall mount(DS-1273ZJ-130-TRL)	Hik white Aluminum alloy 157×184.8×53.4mm 621g	Hik white Aluminum alloy 157×165.7×61.8mm 586g	



Product form	Model	Relevant brackets and housings				
		Indoor/Outdoor				
Mini dome camera 13	DS-2CE56C0T-IT1/IT3 DS-2CE56D0T-IT1/IT3 DS-2CE56D7T-IT1/IT3 DS-2CE56F7T-IT1/IT3 DS-2CE56F1T-IT1/IT3 DS-2CE56H1T-IT1/IT3 DS-2CC52D9T-IT3E					
	DS-1272ZJ-110-TRS	DS-1275ZJ-SUS	DS-1276ZJ-SUS	DS-1280ZJ-S	DS-1281ZJ-S	
	Wall mount	Vertical pole mount	Corner mount	Junction box	Inclined ceiling mount	
	Hik white Aluminum alloy 110×120×120mm 420g	Hik white Stainless Steel 127×46×250mm Diameter of clamp: Ø67-127mm 1205g Match up with wall mount (DS-1272ZJ-110)	Hik white Stainless Steel 126X105X250mm 2280g Match up with wall mount (DS-1272ZJ-110)	Hik white Aluminum alloy 137×53.4×164.8mm 527g	Hik white Aluminum alloy 137×56.5×147mm 472g	

www.magazijnrichtingshop.nl - info@magazijnrichtingshop.nl - tel. +31(0)26-3633683







BRACKET

IP CAMERA





Product form	Model	Relevant brackets and housings					
Box camera 14	DS-2CD40XXF(WD)-XXXX DS-2CD4CXFW	Indoor		Indoor housing		Outdoor housing	
							
		DS-1299ZJ	DS-1292ZJ	DS-1332HZ	DS-1330HZ	DS-1331HZ Series	DS-1340HZ
		Pendant Mount	Wall mount	Indoor housing	Indoor housing	Outdoor housing	Outdoor housing
		Hik white Aluminum Alloy 77×77×198mm 165g	Hik white Aluminum alloy 70×97.1×217.9mm 201g	Hik white Aluminum alloy 288×149×100mm 800g	Hik white Complex fiber 290×142×92mm 640g	Hik white Aluminum alloy	Three-axis adjustment Containing combined wires and fan IK10

Product form	Model	Relevant brackets and housings
Box camera 14	DS-2CD20XX DS-2CD20X5FWD-I	Indoor/Outdoor
		
		DS-1280ZJ-XS
		Junction box
		Hik white Aluminum Alloy Φ100 x 43.2 x 129mm 320g

Product form	Model	Relevant brackets and housings	
Bullet camera 40	DS-2CD26X5FWD-IZS	Indoor/Outdoor	
			
		DS-1475ZJ-SUS	DS-1476ZJ-SUS
		Vertical pole mount	Corner mount
		Hik white Stainless Steel 127×46×250mm Diameter of clamp: Φ67-127mm 1205g	Hik white Stainless Steel 126×105×250mm 2280g

Product form	Model	Relevant brackets and housings				
Bullet camera 17	DS-2CD2622FWD-I(W)(S) DS-2CD2642FWD-I(Z)(S)	Indoor/Outdoor			Outdoor	
						
		DS-1260ZJ	DS-1275ZJ-SUS	DS-1280ZJ-S	DS-1276ZJ-SUS	Rubber sleeve
		Junction box	Vertical pole mount	Junction box	Corner mount	Rubber sleeve with weather proof
		Hik white Aluminum alloy Φ105 mm	Hik white Stainless Steel 127×46×250mm Diameter of clamp: Φ67-127mm 1205g	Hik white Aluminum alloy Φ137 x 53.4x 164.8mm 527g	Hik white Stainless Steel 126×105×250mm 2280g	Hik white Rubber





www.magazijnrichtingshop.nl - info@magazijnrichtingshop.nl - tel. 020-3633683

Product form	Model	Relevant brackets and housings			
		Indoor/Outdoor			
Bullet camera 23	DS-2CD2TXX				
		DS-1275ZJ-SUS	DS-1280ZJ-S	DS-1280ZJ	DS-1276ZJ-SUS
		Vertical pole mount	Junction box	Junction box	Corner mount
		Hik white Stainless Steel 127×46×250mm Diameter of clamp: Ø67-127mm 1205g	Hik white Aluminum alloy 137×53.4×164.8mm 527g	Hik white Aluminum alloy Ø105 mm	Hik white Stainless Steel 126X105X250mm 2280g

Product form	Model	Relevant brackets and housings		
		Indoor/Outdoor		
Bullet camera 24	DS-2CD4AXXF(WD)-I(Z)(H)(S)			
		DS-1275ZJ-SUS	DS-1276ZJ-SUS	Rubber sleeve
		Vertical pole mount	Corner mount	Rubber sleeve with weather proof
		Hik white Stainless Steel 127×46×250mm Diameter of clamp: Ø67-127mm 1205g	Hik white Stainless Steel 126X105X250mm 2280g	Hik white Rubber

Product form	Model	Relevant brackets and housings	
		Indoor/Outdoor	
Bullet camera 28	DS-2CD20XXF(WD)-I(W)		
		DS-1280ZJ-S	
		Junction box	
		Hik white Aluminum alloy 137×53.4×164.8mm 527g	





Product form	Model	Indoor/Outdoor
	DS-2CD46XXF(WD)-I(Z)(H)(S)	
		DS-1275ZJ-4626
		Vertical Pole Mount Hik white Steel(mounting board) & Stainless Steel(clamp) 127×46×250mm 1235g

Product form	Model	Relevant brackets and housings					
		Indoor/Outdoor					
Box camera	DS-2CD40XXF/E-(H)(IR5)(IRA) DS-2CD40XXFWD/E-(H)(IR5)(IRA) DS-2CD40xxFWD/E-(H)(IR5)(3.8-16mm) DS-2CD40xxFWD/E-(H)(IRA)(11-40mm) DS-2CD4026FWD/E-(H)(7-33mm)						
		DS-1293ZJ	DS-1214ZJ	DS-1275ZJ-SUS	DS-1269ZJ	DS-1233ZJ	DS-1276ZJ
		Wall mount	Horizontal pole mount	Vertical pole mount	Pendant Mount	Column Mount	Corner mount
		Hik white Aluminum alloy 88×116.6× 297.3mm 473g	Hik white Steel(mounting board) & Stainless Steel(clamp) 117×226×194mm Diameter of clamp: Ø67- 127mm 1895g	Hik white Stainless Steel 127×46×250mm Diameter of clamp: Ø67- 127mm 1205g Match up with wall mount(DS- 1293ZJ)	Hik white Aluminum alloy 493×246×88mm 480g	Hik white Steel Ø160 x 1093mm 6200g	Hik white Stainless Steel 126×105×250mm 2280g Match up with wall mount(DS- 1293ZJ)









Product form	Model	Relevant brackets and housings					
Dome camera 7	DS-2CD2520F DS-2CD2510F DS-2CD2522FWD-I(W)(S) DS-2CD2542FWD-I(W)(S)	Indoor/Outdoor					
							
		DS-1272ZJ-120 Wall mount	DS-1272ZJ-120B Wall mount	DS-1271ZJ-120 Pendant mount	DS-1276ZJ-SUS Corner mount	DS-1282ZJ-DM mini Gang box	DS-1280ZJ-DM22 Junction box
		Hik white Aluminum alloy 120×122×173.5mm 430g	Hik white Aluminum alloy with junction box 123×180×223mm 1225g	Hik white Aluminum alloy Ø150×573mm 1900g	Hik white Stainless Steel 126×105×250mm 2280g Match up with wall mount(DS-1272ZJ-120)	Hik white Plastic Ø120 mm	Hik white Aluminum alloy 164.8×137×53.4mm 520g

Product form	Model	Relevant brackets and housings								
Dome camera 18	DS-2CD21XXF-I(W)(S) DS-2CD2122FWD-I(W)(S) DS-2CD2142FWD-I(W)(S) DS-2CD21X5FWD-I(S) DS-2CD2125FWD-IM	Indoor/Outdoor(suitable for indoor)								
										
		DS-1259ZJ Inclined ceiling mount	DS-1271ZJ-110 Pendant mount	DS-1272ZJ-110 Wall mount	DS-1272ZJ-110B Wall mount	DS-1276ZJ-SUS Corner mount	DS-1280ZJ-DM18 Junction box	DS-1258ZJ Wall mount	DS-1253ZJ-M Rain shade	DS-1250ZJ Rain shade
		Hik white ABS Plastic Ø111×39.2mm 200g	Hik white Aluminum alloy Ø150×560mm 1900g	Hik white Aluminum alloy 120×122×169mm 420g	Hik white Aluminum alloy with junction box 123×180×227.8mm 1205g	Hik white Stainless Steel 126×105×250mm 2280g Match up with wall mount(DS-1272ZJ-110)	Hik white Aluminum alloy Ø115.4×43.8mm 450g	Hik white ABS plastic 120×111×161.5mm 200g	Hik white Composite Fibre Ø191.1×76mm 133g Match up with wall mount(DS-1272ZJ-110)	Hik white Composite Fibre 264.7*152*189.6 mm 199g





Product form	Model	Relevant brackets and housings										
Dome camera 21	DS-2CD2722FWD-I(Z)(S) DS-2CD2742FWD-I(Z)(S)	Indoor/Outdoor										
												
		DS-1271ZJ-135 Pendant mount	DS-1273ZJ-135 Wall mount	DS-1273ZJ-135B Wall mount with junction box	DS-1275ZJ-SUS Vertical pole mount	DS-1276ZJ-SUS Corner mount	DS-1227ZJ In-ceiling mount	DS-1280ZJ-DM21 Junction box	DS-1281ZJ-DM23 Inclined ceiling mount	DS-1253ZJ-L Rain shade	DS-1250ZJ Rain shade	DS-1258ZJ-L Wall mount
		Hik white Aluminum alloy 150×150×565mm 1900g	Hik white Aluminum alloy 136×183.5×230mm 704g	Hik white Aluminum alloy with junction box 136×243×290mm 1490g	Hik white Stainless Steel 127×46×250mm Diameter of clamp: Ø67-127mm 1205g Match up with wall mount(DS-1273ZJ-135)	Hik white Stainless Steel 126×105×250mm 2280g Match up with wall mount(DS-1273ZJ-135)	Hik white Aluminum alloy & ABS Plastic Ø210×90mm 540g	Hik white Aluminum alloy 162×137×42mm 250g	Hik white Aluminum alloy 136×136.3×48mm 245g	Hik white Composite Fibre Ø225.1×98mm 198g Match up with wall mount(DS-1273ZJ-135)	Hik white Composite Fibre 264.7*152*189.6 mm 199g	Hik white Plastic 136×183×213mm 260g









Product form	Model	Relevant brackets and housings			
		Indoor/Outdoor			
	DS-2CD27X5FWD-IZS				
		DS-1471ZJ-155 Pendant Mount	DS-1473ZJ-155 Wall Mount	DS-1475ZJ-SUS Vertical pole mount	DS-1476ZJ-SUS Corner mount
		Hik white Aluminum alloy Ø155×150×565mm	Hik white Aluminum alloy 155×183.5×240mm	Hik white Stainless Steel 127×46×250mm Diameter of clamp: Ø67-127mm 1205g Match up with wall mount(DS-1473ZJ-155)	Hik white Stainless Steel 126X105X250mm 2280g Match up with wall mount(DS-1473ZJ-155)

Product form	Model	Relevant brackets and housings									
		Indoor/Outdoor									
Dome 25	DS-2CD6362F-I(S)(V) DS-2CD6332FWD-I(S)(V) DS-2CD63C2F-I(V)(S)										
		DS-1271ZJ-DM25 Pendant mount	DS-1273ZJ-DM25 Wall mount	DS-1280ZJ-DM25 Junction box	DS-1281ZJ-DM25 Inclined ceiling mount	DS-1283ZJ Three axis adjustment	DS-1275ZJ-SUS Vertical pole mount	DS-1276ZJ-SUS Corner mount	DS-1274ZJ-DM25 Corner mount	DS-1281ZJ-DM25-B Pendant mount	
		Hik white Alluminum alloy Ø149.5×555mm 1930g	Hik white Aluminum alloy 183.5×164×231.7mm 900g	Hik white Aluminum alloy 178.5×164×41mm 340g	Hik white Aluminum alloy 157.1×164×45.5mm 300g	Hik white Aluminum alloy 167.5×167.5 ×48.7mm	Hik white Stainless Steel 127×46×250mm Diameter of clamp: Ø67-127mm 1205g Match up with wall mount(DS-1283ZJ)	Hik white Stainless Steel 126X105X250mm 2280g Match up with wall mount(DS- 1273ZJ-130, DS- 1283ZJ)	Hik white Aluminum alloy 209×195×114mm	Hik white Aluminum alloy 161×156×165.5mm	

Product form	Model	Relevant brackets and housings							
		Indoor/Outdoor							
Dome 26	DS-2CD45XXF(WD)-I(Z)(H)(S)								
		DS-1273ZJ-DM26 Wall mount	DS-1273ZJ-DM26-B Wall mount with junction box	DS-1271ZJ-DM26 Pendant mount	GP-FE1 Gang box for junction box (special for US market)	DS-1250ZJ Rain shade	DS-1275ZJ-SUS Vertical pole mount	DS-1276ZJ-SUS Corner mount	DS-1227ZJ-DM26 In-ceiling Mount
		Hik white Alluminum alloy 255×225.7×185mm 1550g	Hik white Alluminum alloy 314.5×260×184.9mm 2050g	Hik white Alluminum alloy 676×185×185mm 2150g	Hik white Steel Ø195mm	Hik white Composite Fibre 264.7*152*189.6 mm 199g	Hik white Stainless Steel 127×46×250mm Diameter of clamp: Ø67-127mm 1205g Match up with wall mount(DS-1273ZJ- DM26	Hik white Stainless Steel 126X105X250mm 2280g Match up with wall mount(DS-1273ZJ-130)	Hik white Aluminum alloy Ø225×98mm

Product form	Model	Relevant brackets and housings					
		indoor/Outdoor					
Dome 32	DS-2CD4D16/26FWD-IZ(S)						
		DS-1273ZJ-DM32	DS-1271ZJ-DM32	DS-1275ZJ-SUS	DS-1276ZJ-SUS	DS-1227ZJ-DM32	
		Wall mount	Pendent mount	Vertical pole mount	Corner mount	In-ceiling Mount	
		Hikvision white Aluminum alloy 183.5×142×232mm	Hikvision white Aluminum alloy Ø150×565mm	Hik white Stainless Steel 127×46×250mm Diameter of clamp: Ø67-127mm 1205g Match up with wall mount(DS-1273ZJ-DM32)	Hik white Stainless Steel 126X105X250mm 2280g Match up with wall mount(DS-1273ZJ-DM32)	Hik white Aluminum alloy Ø225×98mm	

Product form	Model	Relevant brackets and housings			
		Indoor			
Dome 27	DS-2CD29XF-II(S) DS-2CD2935FWD-I(S) DS-2CD2955FWD-IS				
		DS-1294ZJ	DS-1281ZJ-DM27	DS-1297ZJ	DS-1299ZJ
		Wall mount	Inclined ceiling mount	Pendant mount (extendable)	Pendant Mount
		Hik white Toughened Plastic 223.9×80×125.8mm 450g	Hik white Plastic 111.8×40.5×108.3mm 45.8g	Hik white Aluminum alloy (Hight 1000-2000mm)	Hik white Aluminum Alloy 77×77×198mm 165g

Product form	Model	Relevant brackets and housings						
		Indoor/Outdoor						
Mini dome camera 8	DS-2CD2322WD-I DS-2CD2342WD-I							
		DS-1273ZJ-130-TRL	DS-1275ZJ-SUS	DS-1276ZJ-SUS	DS-1280ZJ-DM8	DS-1281ZJ-M	DS-1280ZJ-M	DS-1271ZJ-130-TRL
		Wall mount	Vertical pole mount	Corner mount	Junction box	Inclined ceiling mount	Junction box	Pendant mount
		Hik white Aluminum alloy 131×183.5×228.5mm 890g	Hik white Stainless Steel 127×46×250mm Diameter of clamp: Ø67-127mm 1205g Match up with wall mount(DS-1273ZJ-130-TRL)	Hik white Stainless Steel 126X105X250mm 2280g Match up with wall mount(DS-1273ZJ-130-TRL)	Hik white Aluminum alloy Ø126.7mm×35mm	Hik white Aluminum alloy 157×165.7×61.8mm 586g	Hik white Aluminum alloy 157×184.8×53.4mm 621g	Hikvision white Aluminum alloy Ø150×567mm





www.magazijnrichtingshop.nl - info@magazijnrichtingshop.nl - tel. +31(0)26-3633683

Product form	Model	Relevant brackets and housings					
		Indoor/Outdoor					
Mini dome camera 18	DS-2CD23X5FWD-I						
	DS-1273ZJ-130-TRL	DS-1275ZJ-SUS	DS-1276ZJ-SUS	DS-1280ZJ-DM23	DS-1281ZJ-M	DS-1271ZJ-130-TRL	
	Wall mount	Vertical pole mount	Corner mount	Junction box	Inclined ceiling mount	Pendant mount	
	Hik white Aluminum alloy 131×183.5×228.5mm 890g	Hik white Stainless Steel 127×46×250mm Diameter of clamp: Ø67-127mm 1205g Match up with wall mount(DS-1273ZJ-130-TRL)	Hik white Stainless Steel 126X105X250mm 2280g Match up with wall mount(DS-1273ZJ-130-TRL)	Hik white Aluminum alloy Ø126.7mm×35mm	Hik white Aluminum alloy 157×165.7×61.8mm 586g	Hikvision white Aluminum alloy Ø150×567mm	







Product form	Model	Relevant brackets and housings					
		Indoor/Outdoor					
	DS-2CD2HX5FWD-IZS						
	DS-1473ZJ-135	DS-1471ZJ-135	DS-1281ZJ-DM23	DS-1475ZJ-SUS	DS-1476ZJ-SUS	DS-1473ZJ-135B	
	Wall mount	Pendant mount	Inclined ceiling mount	Vertical pole mount	Corner mount	Wall mount with junction box	
	Hik white Aluminum alloy 136×183.5×230mm 704g	Hik white Aluminum alloy 150×150×565mm 1900g	Hik white Aluminum alloy 136.3×136.3×48mm 245g	Hik white Stainless Steel 127×46×250mm Diameter of clamp: Ø67-127mm 1205g Match up with wall mount(DS-1473ZJ-135)	Hik white Stainless Steel 126X105X250mm 2280g Match up with wall mount(DS-1473ZJ-135)	Hik white Aluminum alloy with junction box 136×243×290mm 1490g	

Product form	Model	Relevant brackets and housings	
		Indoor	
PT 5	DS-2CD2F22FWD-I(W)(S) DS-2CD2F42FWD-I(W)(S)		
	DS-1294ZJ	DS-1280ZJ-PT3	
	Wall mount	Junction box	
	Hik white Toughened Plastic 223.9×80×125.8mm 450g	Hik white Plastic Ø120×40mm 104g	

www.magazijninrichtingshop.nl - 020-351(0)26-3633683

Product form		Model	Relevant brackets and housings		
Dual-lens		iDS-2CD6810F/C	indoor		
					
			DS-1227ZJ-P1 In-ceiling mount Hik white Ø253.4×8.5mm	DS-2102ZJ Wall mount Hik white 194×110×50mm	DS-1299ZJ Pendant Mount Hik white Aluminum Alloy 77×77×198mm 165g

Product form		Model	Relevant brackets and housings				
Dome 30		DS-2CD6986F-(H)	Outdoor				
							
			DS-1271ZJ-DM30-E Pendant mount Hik white Aluminum alloy Ø205.6×359mm 1920g	DS-1605ZJ-DM30 Wall mount Hik white Aluminum alloy 205.6×183.5×333.6mm 1620g	DS-1280ZJ-BQ30 Junction Box Hik white Aluminum alloy Ø195×38.5mm	DS-1275ZJ-SUS Vertical pole mount Hik white Stainless Steel 127×46×250mm Diameter of clamp: Ø67-127mm 1205g Match up with wall mount(DS-1605ZJ-DM30)	DS-1276ZJ-SUS Corner mount Hik white Stainless Steel 126×105×250mm 2280g Match up with wall mount(DS-1605ZJ-DM30)

Product form		Model	Relevant brackets and housings				
PanoVu		DS-2CD6A64F-IHS/NFC	Outdoor				
							
			DS-1602ZJ-P Wall mount Grey Aluminum alloy 97×182×305mm	DS-1663ZJ-P Pendant mount Grey Aluminum alloy Ø116.5×57mm	DS-1673ZJ-P Horizontal pole mount Grey Steel Diameter of the clamp Ø67-127mm Match up with DS-1661ZJ-P, DS-1663ZJ-P	DS-1602ZJ-pole-P Vertical pole mount Grey Aluminum alloy 117×194×310mm	DS-1661ZJ-P Pendant mount Grey Aluminum alloy Ø116.5×200mm

www.magazijnrichtingshop.nl - info@magazijnrichtingshop.nl - tel. +31(0)26-3633683







BRACKET

PTZ AND ZOOM CAMERA

Product form	Model	Relevant brackets and housings				
		Indoor				
3" Mini PTZ	DS-2DE3204W-DE					
		DS-1227ZJ-PT6	DS-1273ZJ-PT6	DS-1280ZJ-PT6	DS-1275ZJ-SUS	DS-1276ZJ-SUS
		In-ceiling mount	Wall mount	Junction Box	Vertical pole mount	Corner mount
		Hik white Steel+Platic Ø210×79.3mm	Hik white 183.5×140×232mm	Hik white Aluminum alloy 136.5×42×162.5mm 280g	Hik white Stainless Steel 127×46×250mm Diameter of clamp: Ø67-127mm 1205g Match up with DS_1273ZJ-PT6	Hik white Stainless Steel 126×105×250mm 2280g Match up with DS_1273ZJ-PT6

Product form	Model	Relevant brackets and housings					
		Outdoor					
IR PTZ 9	DS-2DE4220IW-DE						
		DS-1661ZJ	DS-1662ZJ	DS-1663ZJ	DS-1618ZJ	DS-1660ZJ	DS-1604ZJ
		Pendant mount	Pendant mount	Ceiling mount	Wall mount(short arm)	Parapet wall mount	Wall mount
		Hik white Aluminum alloy Ø116.5×200mm 600g	Hik white Aluminum alloy Ø116.5×500mm 960g	Hik white Aluminum alloy Ø116.5×57mm 380g	Hik white Aluminum alloy 110×145×189mm 550g	Hik white Aluminum alloy 180×950×800mm 2900g	Hik white Aluminum alloy 255×171×355.5mm 2150g
							
DS-1604ZJ-pole	DS-1604ZJ-corner	DS-1604ZJ-box	DS-1604ZJ-BOX-POLE	DS-1604ZJ-BOX-CORNER	DS-1619ZJ	DS-1671ZJ-SDM9	
Vertical pole mount	Corner mount	Wall mount with junction box	Vertical Pole Mount with junction box	Wall Mount with junction box	Gooseneck mount	In-ceiling mount	
Hik white Aluminum alloy 170.7×261.8×355.5mm	Hik white Aluminum alloy 206.8×261.8×465mm	Hik white Aluminum alloy 281.2×170.7×395.5mm	Hik white Aluminum alloy & steel 222×139.3×422mm	Hik white Aluminum alloy & stee 255.5×314×542.5mm	Hik white Aluminum alloy 455.2×130.4×841.5mm	Hik Black Steel + plastic Ø232.9×142.6mm	

www.magazijnrichtingshop.nl - info@magazijnrichtingshop.nl - tel. +31(0)26-3633683

Product form	Model	Relevant brackets and housings					
		Outdoor(only available for outdoor PTZ model)					
PT11	DS-2DE4A220IW-DE						
		DS-1605ZJ	DS-1671ZJ-SD11	DS-1280ZJ-SD11	DS-1691ZJ-L	DS-1691ZJ-M	DS-1691ZJ
		Wall Mount Bracket	In-ceiling Mount Bracket	Junction Box	Pendant mount	Pendant mount	Pendant mount
		Hik white Aluminum alloy 183.5×120×228.6mm 1120g	Hik white Aluminum alloy ∅233×85mm	Hik white Aluminum alloy ∅158×40mm	Hik white Steel 124×84×1000mm 2175g	Hik white Steel 124×84×500mm 1175g	Hik white Aluminum alloy 84×124×335mm 980g

Product form	Model	Product form	Model	Product form	Model	Product form	Model	Product form	Model		
5 inch with IR	DS-2DE5XXXI DS-2AE5XXXTI DS-2AE5XXXTI-A(B)	5 inch without IR	DS-2AE5XXX DS-2DE5XXX	IR PTZ Dome Camera4	DS-2AE7XXX DS-2DE7XXX	6 inch	DS-2DF6XXX	8 inch	DS-2DF8XXXI DS-2DF82XXIW-AEL DS-2DF883615V-AEL DS-2DF82XXI-AEL(B)		
											
Relevant brackets and housings											
Outdoor(only available for outdoor PTZ model)											
											
DS-1661ZJ	DS-1662ZJ	DS-1663ZJ	DS-1660ZJ	DS-1604ZJ	DS-1604ZJ-pole	DS-1604ZJ-corner	DS-1604ZJ-box	DS-1604ZJ-BOX-POLE	DS-1604ZJ-BOX-CORNER	DS-1619ZJ	DS-1667ZJ
Pendant mount	Pendant mount	Ceiling mount	Parapet wall mount	Wall mount	Vertical pole mount	Corner mount	Wall mount with junction box	Vertical Pole Mount with junction box	Wall Mount with junction box	Gooseneck mount	Extendable pole for Pendant mount
Hik white Aluminum alloy ∅116.5×200mm 600g	Hik white Aluminum alloy ∅116.5×500mm 960g	Hik white Aluminum alloy ∅116.5×57mm 380g	Hik white Aluminum alloy 180×950×800mm 2900g	Hik white Aluminum alloy 255×171×355.5mm 2150g	Hik white Aluminum alloy 170.7×261.8 ×355.5mm	Hik white Aluminum alloy 206.8×261.8 ×465mm	Hik white Aluminum alloy 281.2×170.7 ×395.5mm	Hik white Aluminum alloy & steel 222×139.3×422mm	Hik white Aluminum alloy & steel 255.5×314 ×542.5mm	Hik white Aluminum alloy 455.2×130 .4×841.5mm	Hik white Galvanized steel pipe 1500-2500mm

Product form	Model	Relevant brackets and housings							
PanoVu	DS-2DP0818Z-D DS-2DP1636Z-D DS-2DP1636-D	Outdoor							
									
		DS-1603ZJ	DS-2663ZJ	DS-1668ZJ	DS-1668ZJ(20)	DS-1673ZJ	DS-1684ZJ	DS-1678ZJ	DS-1619ZJ-P
		Wall mount	3-axis Mount	Pendant mount	Pendant mount	Horizontal pole mount	Vertical Pole mount	Junction Box	Gooseneck mount
		Hik white Aluminum alloy 98×182×362mm	Hik white Aluminum alloy 275.8×269×140.1mm 2600g Note: Only for DS-2DP1636-D	Hik white Steel Ø115×58mm 620g	Hik white Steel Ø115×200mm 1150g	Hik white Steel(mounting board) & Stainless Steel(clamp) Diameter of clamp: Ø67-127mm Match up with pendant mount	Hik white Steel(mounting board) & Stainless Steel(clamp) Diameter of clamp: Ø67-127mm Match up with Wall mount	Hik white Aluminum alloy 286×424×119.5mm	Hik white Steel 455×130×815.5mm

Product form	Model	Relevant brackets and housings
PanoVu PT	iDS-2PT9122IX-D/S Wall mount bracket included in the package	Outdoor
		
		DS-2664ZJ
		Pendant mount
		Grey Aluminum alloy Ø203.5×217.4mm

www.magazijninrichtingshop.nl - info@magazijninrichtingshop.nl - tel. +31(0)26-3633683